



Operational & Maintenance Manual

Products:

Installation Site

Contractor

Architect

Distributor



Dear Customer:

Thank you for choosing [^] as your custom door installation specialist.

The Operation and Maintenance Manual, which is enclosed, has been supplied by Overhead Door Corporation to meet your needs as our customer. Appropriate information for the products installed has been compiled in this manual for your use. We recommend compliance with all of the safety information provided within the manual.

We strongly recommend implementing a preventative maintenance program. Benefits of properly maintaining your door system include:

- Increased operational efficiency and reliability.
- Extended useful life of your equipment.
- Increased probability of dependable equipment performance.
- Elimination of non-budgeted maintenance cost for door service.

As an Overhead Door distributor, we offer you complete product support for your service and maintenance needs. Do not hesitate to call us for assistance.

We hope that you will also continue to consider [^] for your future product and installation needs. We are firmly committed to providing the finest in Overhead Door products, accessories, and a level of customer support unmatched in the industry.

Sincerely,



Operation & Maintenance Manual

Commercial Operators

Table of Contents

Section 1	General Information
Section 2	Preventative Maintenance
Section 3	Installation Instructions
Section 4	Warranty



GENERAL INFORMATION



OVERHEAD DOOR CORPORATION

Overhead Door Corporation, based in Dallas, Texas, is a leading single-source manufacturer of integrated door and operator systems for commercial and residential applications.

Overhead Door is the door solutions provider that delivers expert service and the highest level of performance and reliability. Our comprehensive product line encompasses a wide variety of commercial door solutions including: commercial operators, commercial sectional and rolling service doors, advanced performance rolling doors, and security grilles.

With our nationwide network of more than 400 authorized distributors, we are a leading provider of overhead and garage door systems, and we continue to lead the way with reliable solutions and unmatched professional installation, service and support that keeps customers coming back. The brand trusted for over 90 years, Overhead Door gives home and business owners confidence and peace of mind.

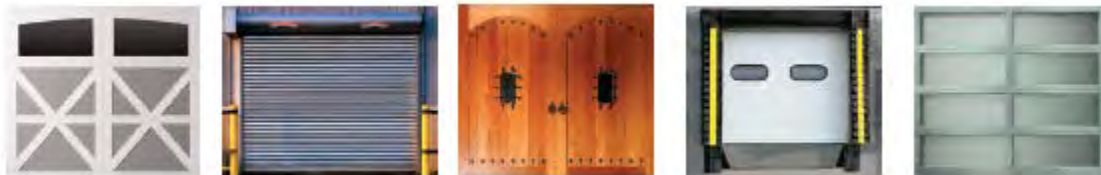

To locate a distributor:

From the United States, call 1-800-929-3667 (DOOR)

International: 1-717-248-0131

<http://www.overheaddoor.com/Pages/distributor-locator.aspx>

Contact Information:

Overhead Door Corporation
2501 S. State Hwy. 121, Suite 200
Lewisville, TX 75067

Telephone: 1-800-275-3290

www.overheaddoor.com



PREVENTATIVE MAINTENANCE



BENEFITS OF PREVENTATIVE MAINTENANCE PROGRAM

- **Increase operational efficiency, safety and reliability**
- **Extend useful life of your equipment**
- **Reduce probability of equipment malfunctioning**
- **Decrease costly downtime**
- **Decrease long-term repair expense**
- **Priority scheduling for service**
- **Establish relationship with experienced, service-oriented professionals**



SCOPE OF WORK FOR ELECTRIC OPERATORS

For the period _____, 20__, through _____, 20__, the following services and inspections will be provided as part of the Preventative Maintenance Program for operator(s):

ELECTRIC OPERATORS:

- 1) Inspect and adjust limit switches.
- 2) Inspect and adjust belts.
- 3) Inspect and adjust brake.
- 4) Inspect gear reducer.
- 5) Inspect operator mounting.
- 6) Inspect and test disconnect.
- 7) Inspect and lubricate roller chain.
- 8) Inspect and tighten all sprockets.
- 9) Inspect safety labels, placement and condition.



INSTALLATION INSTRUCTIONS

RHX[®]
HEAVY DUTY COMMERCIAL OPERATOR

The Genuine. The Original.



HOIST

WITH EXCLUSIVE FEATURES:

Voltamatic™

Limit Lock™

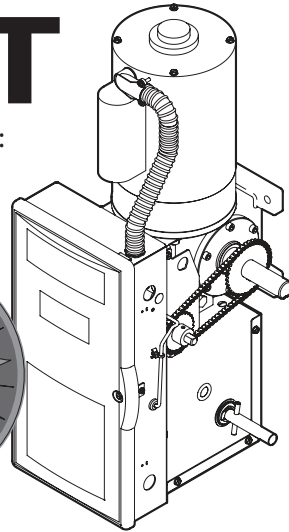
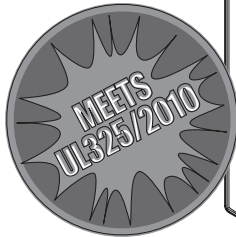

PROPER APPLICATION

Door Type	Operator Type	HP/Max Door Weight
Sectional (All Types)	Hoist (Sidemount, Centermount, Chain or Direct Couple)	1/2HP = 1310 lbs. 3/4HP = 1450 lbs.
Rolling Steel (All Types)	Hoist (Front of Hood, Top of Hood, or Bench Mount)	1HP = 1650 lbs. 3HP = 3696 lbs.

NOT FOR RESIDENTIAL USE

This Installation Manual provides the information required to install, troubleshoot and maintain an RHX[®] Commercial/Industrial Door Operator.

Table of Contents

Section 1	How to use this manual	1.1	Section 7	Special Operational Features	7.1-7.2
Section 2	Safety Information & Instructions	2.1		Operator Cycle Count	7.1
Section 3	Critical Installation Information	3.1-3.3		GDO & Display Firmware	7.1
Section 4	Installation	4.1-4.5		Operator Type	7.2
	Rolling Steel Front/Top of Hood	4.1-4.2	Section 8	Troubleshooting	8.1-8.5
	Rolling Steel Horizontal Front of Hood	4.3		Display Operation	8.1
	Rolling Steel Wall Mount	4.3		Error Codes	8.1-8.2
	Side Mount/Center Mount (Chain Couple)	4-4		Run Codes	8.2-8.3
	Sectional Door Direct Couple	4.5		LED Indicators	8.4
	Sectional Door Center Mount	4.6		Safe-T-Beam® Self-Diagnostic Troubleshooting Chart ..	8.5
	Fire Doors	4.7	Section 9	Service & Maintenance	9.1
	Manual Handwheel/Release Cord	4.8		Periodic Maintenance Schedule	9.1
	Optional Clutch	4.9	Section 10	Appendixes	10.1-10.16
Section 5	Wiring	5.1-5.8		Appendix A	10.1-10.9
	Line Voltage Wiring	5.1		Operator Parts Breakdown (One HP)	10.1
	Low Voltage Control Wiring	5.2		Operator Parts Breakdown (Three HP)	10.2
	External Wire Diagram	5.3		Wall Mount Kit (Chain Couple)	10.3
	Wall Control	5.4		Hoist Shafts Parts Breakdown	10.4
	Interlock Switches	5.5		Motor Options	10.5
	Monitored Photocell Device Wiring	5.6		Clutch & Brake/Release Assemblies	10.6
	Sensing Edge Switch	5.7		Base Electric Box Parts Breakdown	10.7
	External Radio (Optional)	5.8		Electric Box Layout	10.8
	Connecting Motor/Safety Instructions	5.9		Appendix B	10.9
Section 6	Operator Setup Procedures	6.1-6.9		Mounting Kits	10.9
	Setting Close Direction	6.2		Appendix C	10.10
	Setting Braking Rate	6.3		Screw Terminal Assignments	10.10
	Setting Travel Limits	6.4		Appendix D	10.11-10.13
	Setting Up Limit Overrun	6.5		Run Codes	10.11
	Setting Down Limit Overrun	6.6		Error Codes	10.12-10.13
	Setting Open & Close Modes	6.7	Section 11	Warranty	11.1
	(Optional) Transmitter Programming	6.8			
	(Optional) Mid-Stop Limit Setting	6.9			
	Monitored Reversing Devices	6.10			

Section 1: How to use this manual

The 11 sections of this Installation Manual provide the information required to install, troubleshoot and maintain an RHX® commercial/industrial door operator.

Section 2

Provides important defining information related to safety terminology used throughout this manual, as well as safety related instructions which must be followed at all times while doing any steps/tasks/instructions detailed in this manual.

Section 3

Details pre-installation concerns/issues/decisions that are recommended to be considered and/or resolved prior to beginning any commercial door operator installation.

WARNING

Failure to correctly perform all steps in sections 4-6 can result in serious injury or death.

Sections 4-6

Provides step by step installation and set-up instructions for the RHX® commercial door operator. Each section is written such that it must be followed in a step by step order to complete a successful installation.

Sections 7-8

Details important features and troubleshooting information for typical installation and normal operations that may occur.

Sections 9-11

Provides related information on service and maintenance items, operator drawings for use in troubleshooting and service activities, along with important warranty and returned goods policy information.

Section 2: Safety Information & Instructions



⚠ WARNING

Overhead Doors are large, heavy objects that move with the help of springs under high tension and electric motors. Since moving objects, springs under tension, and electric motors can cause injuries, your safety and the safety of others depend on you reading the information in this manual. If you have any questions or do not understand the information presented, call your nearest service representative. For the number of your local Overhead Door Dealer, call 800-929-3667, and for **Overhead Door Factory Technical Advice, call 800-275-6187.**

In this Manual, the words Danger, Warning, and Caution are used to stress important safety information. The word:

- ⚠ DANGER** indicates an imminently hazardous situation which, if not avoided, will result in death or serious injury.
- ⚠ WARNING** indicates a potentially hazardous situation which, if not avoided, could result in death or serious injury.
- ⚠ CAUTION** indicates a potentially hazardous situation which, if not avoided, may result in injury or property damage.

*The word **NOTE** is used to indicate important steps to be followed or important considerations.*

POTENTIAL HAZARD	EFFECT	PREVENTION
 <p>MOVING DOOR</p>	<p>⚠ WARNING Could result in Serious Injury or Death</p>	<p>Do Not operate unless the doorway is in sight and free of obstructions. Keep people clear of opening while door is moving. Do Not allow children to play with the door operator. Do Not change operator control to momentary contact unless an external reversing means is installed. Do Not operate a door that jams or one that has a broken spring.</p>
 <p>ELECTRICAL SHOCK</p>	<p>⚠ WARNING Could result in Serious Injury or Death</p>	<p>Turn off electrical power before removing operator cover. When replacing the cover, make sure wires are not pinched or near moving parts. Operator must be electrically grounded.</p>
 <p>HIGH SPRING TENSION</p>	<p>⚠ WARNING Could result in Serious Injury or Death</p>	<p>Do Not try to remove, repair or adjust springs or anything to which door spring parts are fastened, such as, wood block, steel bracket, cable or any other structure or like item. Repairs and adjustments must be made by a trained service representative using proper tools and instructions.</p>

IMPORTANT READ PRIOR TO ANY DOOR OPERATION

1. Read manual and warnings carefully.
2. Keep the door in good working condition. Periodically lubricate all moving parts of door.
3. If door has a sensing edge, check operations monthly. Make any necessary repairs to keep it functional.
4. **AT LEAST** twice a year, manually operate door by disconnecting it from the operator. The Door should open and close freely. If it does not, the door must be taken out of service and a trained service representative must correct the condition causing the malfunction.
5. The Operator Motor is protected against overheating by an internal thermal protector. If the operator ceases to function because motor protector has tripped, a trained service technician may need to correct the condition which caused the overheating. When motor has cooled, thermal protector will automatically reset and normal operation can be resumed.
6. In case of power failure, the door can be operated manually by pulling the release cable to disconnect the operator drive system.
7. Keep instructions in a prominent location near the pushbutton.

Section 3: Critical Installation Information

Job Site Issues to Consider/Concerns

The following list of items should be considered prior to selecting an operator for a given job site.

1-Available power supply. 2-Type of door. 3-Potential operator mounting obstructions. Items to consider include, but are not limited to: side room, room above door shaft, room below door shaft, available mounting surface integrity, power supply location, and convenient chain hoist and release cable positioning. 4-Size of door for appropriate operator torque and door travel speed selection. 5-Operator mounting environment. Items to consider include operator location, dampness of location, dustiness of the location and corrosiveness of the location. 6-Door activation needs/requirements. Examples include 3 button control stations, 1 button control stations, radio controls, pull cords, loop detectors, photoelectric controls, key switches, etc. See "Entrapment Protection" section below. 7-Interlock switches are required under certain conditions for doors with pass doors and door locks. See Section 5.5 below. 8-Accessory equipment. Examples include reversing edges and/or photocell beams, which are required for doors set to operate as momentary contact, auxiliary control relays, warning lights, etc.

See "Entrapment Protection" section below.

ENTRAPMENT PROTECTION (See also page 3.2)

The installation of a fail safe external reversing device (such as a monitored reversing edge or photocell system, etc.) is required on all momentary contact electronically operated commercial doors. If such a reversing device is not installed, the operator will revert to a constant contact control switch for operation (Closing only).

The Reversing Devices currently UL Approved are:

- 1) Miller Edge ME series model edge sensors used in combination with Timer-Close Module P/N OPABTCX.S.
- 2) Safe-T-Beams® from both Genie® and Overhead Door®.
- 3) Commercial Photoeye Kit P/N OPAKPE.S.

⚠ WARNING: DO NOT apply line voltage until instructed to do so.

⚠ CAUTION:

Check working condition of door before installing the operator. Door must be free from sticking and binding. If equipped, deactivate any door locking device(s). Door repairs and adjustments, including cables and spring assemblies **MUST** be made by a trained service representative using proper tools and instructions.

Section 3: Critical Installation Information

ENTRAPMENT PROTECTION

The RHX® can be used with the following UL Approved entrapment devices in compliance with UL325 requirements active starting August 29, 2010.

UNTIL ONE OF THESE MONITORED EXTERNAL ENTRAPMENT DEVICES IS INSTALLED, THE RHX® WILL NOT ALLOW MOMENTARY CONTACT OPERATION IN THE CLOSE DIRECTION.

APPROVED DEVICES	ALLOWABLE DOOR WIDTH	ALLOWABLE DOOR HEIGHT
Miller Edge ME series model edge sensors used in combination with Timer-Close Module P/N OPABTCX.S.	ANY WIDTH	See Sq-Ft Charts below Max. Door Height = 24ft. Over 24ft. —contact factory
Safe-T-Beams® from both Genie® and Overhead door®	30 FEET	
Commercial Photoeye Kit P/N OPAKPE.S.	30 FEET	

RHX™ Sectional Door Chart (Sq. Ft.)																												
Model	HP	UL Listed	Door Series ->	Commercial Steel Insulated & Non-Insulated										Thermacore						Aluminum								
				416		418		420		422		424		426		430		432		591	592	593	594	596	598	599	511	521
				Mounting Type	Max. Door Weight (Lbs)	16GA. Flush Steel	16GA. Flush Steel Insulated	20GA. Ribbed Steel	20GA. Ribbed Steel Insulated	24GA. Ribbed Steel	24GA. Ribbed Steel Insulated	Nominal 24GA. Ribbed Steel	Nominal 24GA. Ribbed Steel Insulated	Ribbed 24GA. Ribbed Steel 1 5/8"	Ribbed Steel 2"	Ribbed Steel 1 3/8"	Raised Panel Steel 1 3/8"	20GA. Flush Steel 2"	Ribbed Steel 1"	Flush Steel 2"								
RHX™	1/2	Yes	TSC	1310	330	262	406	330	448	366	326	326	490	448	326	326	380	200	448	326	406							
RHX™	3/4	Yes	TSC	1450	366	294	490	406	536	448	326	326	536	490	326	326	419	200	448	326	506							
RHX™	1	Yes	TSC	1650	448	366	536	448	632	490	326	326	632	584	326	326	501	200	448	326	526							
RHX™ w/14 RPM Direct Couple Kit	1	Yes	SC	2400	490	406	684	536	792	584	326	326	792	736	326	326	591	200	448	326	526							
RHX™ w/14 RPM Direct Couple Kit	3	Yes	SC	3696	701	588	1020	821	1020	821	326	326	1164	1020	326	326	888	200	448	326	526							

T = Trolley, S = Jackshaft, Side Mount, C = Jackshaft, Center Mount

Note: Side/center direct couple kit output speed is 26RPM for 1/2, 3/4, and 1hp. For large doors use 14RPM output speed direct couple kit on 1, and 3HP RHX Operators.

Note: Total door weight, and not the square footage, is the critical factor in selecting the proper operator. Square foot measurements are based on "square doors". (Example = 16' x 16')

Note: Doors that require special windloading and wide doors normally require increased strutting (reinforcement). Strutting doors can significantly increase door weight beyond maximum weight shown. Consult factory personnel in these situations.

RHX™ Rolling Steel Door Chart (Sq. Ft.)																									
Model	HP	Max Output Torque in*lbs	UL Listed	Rolling Steel Doors										Fire King		Rolling Fire Doors / Fire Shutters				Counter		Grilles			
				600		610		610/620		625		635		635		630/631/634		640/641		650/651/65		670		671	
				Coilaway	24GA.	22GA.	20GA.	18GA.	24GA.	22GA.	20GA.	18GA.	24GA.	22GA.	24GA.	22GA.	20GA.	18GA.	22GA.	22GA.	22GA.	22GA.	Alum	Alum	Steel
RHX™	1/2	466	Yes	256*	465	403	351	268	247	215	199	169	247**	215**	172**	168**	351**	268**	N/A	ALL*	540	240			
RHX™	3/4	570	Yes	256*	580	502	437	334	307	268	248	211	307**	268**	172**	168**	416**	334**	N/A	ALL*	620	290			
RHX™	1	667	Yes	256*	690	600	523	399	367	320	297	252	367**	320**	172**	168**	480**	399**	N/A	ALL*	700	340			
RHX™	3	1972	Yes	256*	N/A	1137	945	867	798	696	645	548	798**	696**	172**	168**	576**	696**	N/A	ALL*	1080	888			

Note: Door chart represents max. door height of 24ft., over 24ft high consult factory. * Operator must be wall mounted. **Must use the Auxiliary Input/Output Module part number OPABIOX.S



Section 3: Critical Installation Information

IMPORTANT INSTALLATION INSTRUCTIONS

WARNING -

To reduce the risk of severe injury or death:

- 1) READ AND FOLLOW ALL INSTALLATION INSTRUCTIONS.
- 2) Install only on a properly operating and balanced door. A door that is operating improperly could cause severe injury. Have qualified service personnel make repairs to cables, spring assemblies and other hardware before installing the operator.
- 3) Remove all pull ropes and remove, or make inoperative, all locks (unless mechanically and/or electronically interlocked to the power unit) that are connected to the door before installing the operator.
- 4) Install the door operator at least 8 feet above the floor if the operator has exposed moving parts.
- 5) Do not connect the door operator to the power source until instructed to do so.
- 6) Locate the control station: (a) within sight of the door, (b) a minimum of 5 feet above the floor so that small children cannot reach it, and (c) away from all moving parts of the door.
- 7) Install the Entrapment Warning Placard next to the control station and in a prominent location.
- 8) For products having a manual release, instruct the end user on the operation of the manual release.

Section 4: Installation

Rolling Steel

Front/Top of Hood

(With Optional Mounting Kit)

- 1) Determine operator mounting location, including desired hoist and release location and release cable routing.
- 2) Weld the Rolling Door weld plate assembly to the door headplate, A minimum of two 1" weld beads are required on each side of the weld plate for proper attachment. See **Fig 1** for proper placement.
- 3) Attach operator to main mounting bracket using the four 3/8"-16 X 1-1/4" bolts, hex nuts, and lockwashers. See **Fig 2**.
- 4) Mount the operator to the weld plate using the 7/16"-18 hex nuts. Hand tighten bracket to weld plate nuts. Hand tighten bracket to weld plate nuts.

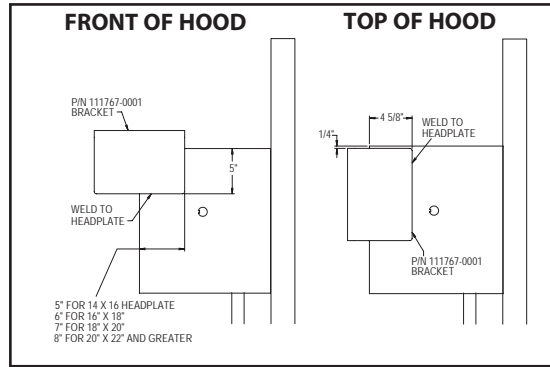

Figure 1 WELD PLATE ATTACHMENT

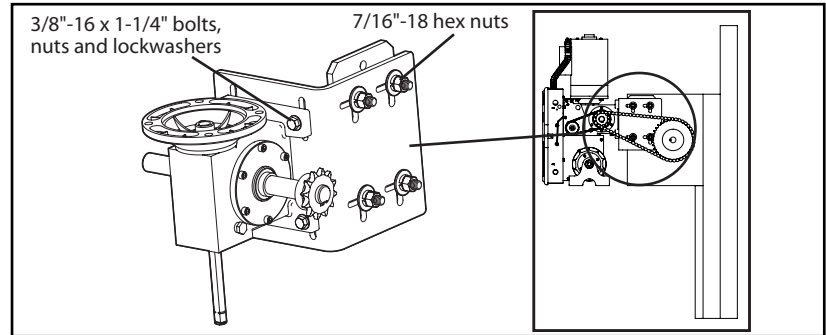

Figure 2 MOUNTING BRACKET BOLT LOCATIONS

HP	OPTIONAL MOUNTING KIT	PART NO.
1/2, 3/4, 1	Rolling Steel-FOH/TOH	OPMKRSHX.S
3	Rolling Steel-FOH/TOH	OPMKRSHX3HP.S

Rolling Steel

Front/Top of Hood (continued)

Attach Operator to Door: **Fig. 3.**

- 5) Attach 12 tooth sprocket to operator output shaft.
- 6) Align keyways and insert key into sprocket and output shaft keyway. Do not tighten set screw at this time.
- 7) Attach door sprocket to door shaft. Do not tighten at this time.
- 8) Assemble chain using chain master link.
- 9) Place assembled chain over door shaft sprocket and around the 12 tooth sprocket.
- 10) Raise or lower operator to remove slack from the chain. Be certain operator output shaft is parallel with door shaft.
- 11) While applying tension to chain, tighten operator mounting bracket nuts.
- 12) Tighten sprocket set screws.

Figure 3

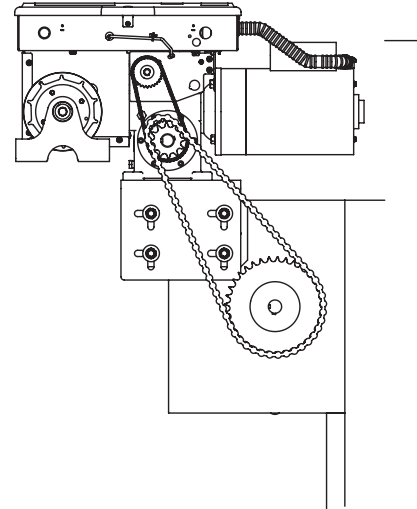

REFER TO SHOP DRAWINGS FOR
SPECIFIC DIMENSIONING INFORMATION.

Rolling Steel Bench Mount

(With Optional Mounting Kit)

The RHX® Rolling Steel Operators are factory assembled for **right-hand** mounting (shown). (Each model can also be converted to left-hand mount.

- 1) Determine operator mounting location, including desired hoist and release location and release cable routing.
- 2) Weld the Rolling Door weld plate assembly to the door headplate, A minimum of two 1" weld beads are required on each side of the weld plate for proper attachment. See **Fig 4** for proper placement.
- 3) Attach operator to main mounting bracket using the four 3/8"-16 X 1-1/4" bolts, hex nuts, and lockwashers.
- 4) Mount the operator to the weld plate using the 7/16"-18 hex nuts. Hand tighten bracket to weld plate nuts.

- 5) Tighten chain using available adjustment of bench mount bracket.
- 6) Fully tighten all bolts/nuts.

HP	OPTIONAL MOUNTING KIT	PART NO.
1/2, 3/4, 1	Rolling Steel-Bench Mount	OPMKRSBMHX.S
3	Rolling Steel-Bench Mount	OPMKRSBMHX3HPS

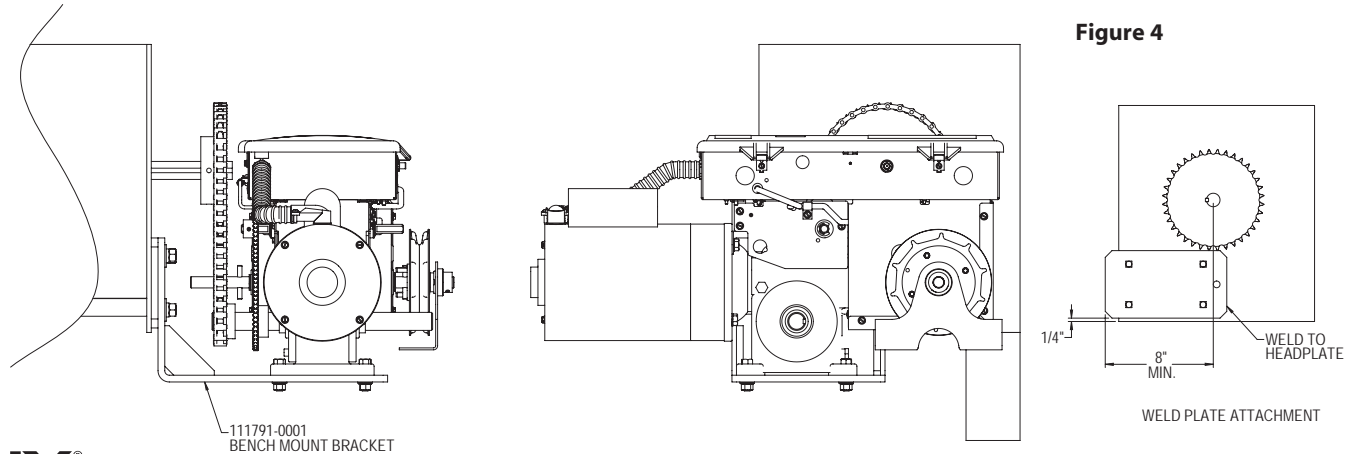

Figure 4

Rolling Steel/Sectional Wall Mount/Side Mount

The RHX® Hoist unit can be wall mounted when required. **Fig. 5, 6 & 7.**

- 1) Attach optional wall mount bracket to operator (if needed) using the 4 mounting bolts and nuts supplied. Fully tighten. Position the operator with the bracket as shown.
- 2) Attach 12 tooth sprocket to operator output shaft.
- 3) Align keyways and insert key into sprocket and door shaft keyway. Do not tighten set screw at this time.
- 4) Attach door sprocket to door shaft. Do not tighten at this time.
- 5) Assemble chain using chain master link.
- 6) Position operator near door shaft with sprockets aligned.
- 7) Place assembled chain over door and operator sprockets.
- 8) Lift or lower the operator as needed to tension drive chain.
- 9) Secure operator to wall.
- 10) Check vertical alignment of the drive chain/sprockets and tighten sprocket set screws.

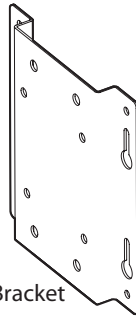

Figure 5
Optional Bracket

HP	OPTIONAL MOUNTING KIT	PART NO.
1/2, 3/4, 1	Wall Mount Kit	OPMKWMHX.S
3	Wall Mount Kit	OPMKWMHX3HP.S

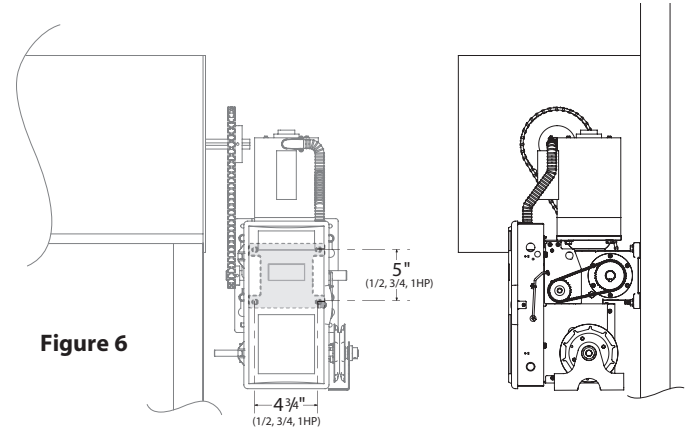

Figure 6

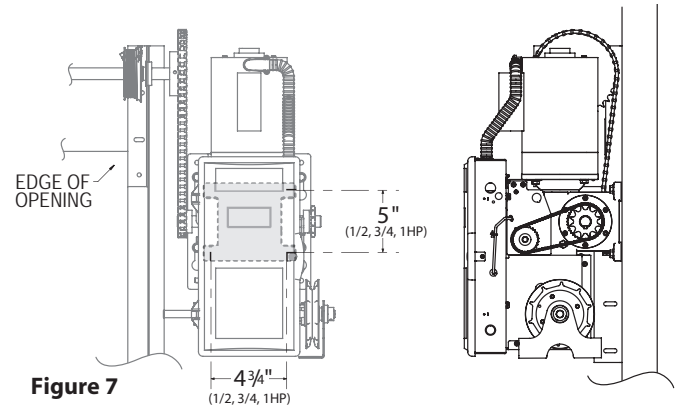

Figure 7

Sectional Doors Direct Couple

Right-Hand unit shown.

NOTES:

1. A CLEARANCE OF 8" SHOULD BE ALLOWED FOR ACCESS TO ELECTRIC BOX.
2. AVERAGE DOOR TRAVEL SPEED VARIES PER DRUM USED.
3. OPERATOR MOUNTING BRACKETS MOUNT TO WALL.

Refer to Direct Couple Supplemental Instruction, P/N 111774.500141 (Included with Direct Couple Kit)

SIDEMOUNT 14 RPM DIRECT COUPLE

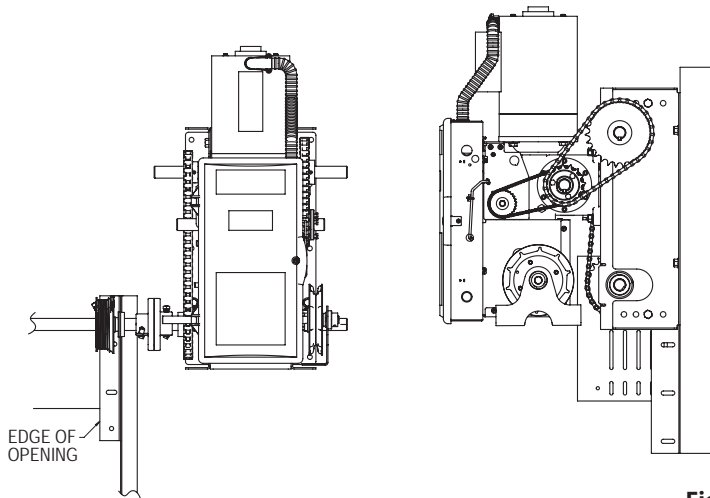

SIDEMOUNT 26 RPM DIRECT COUPLE

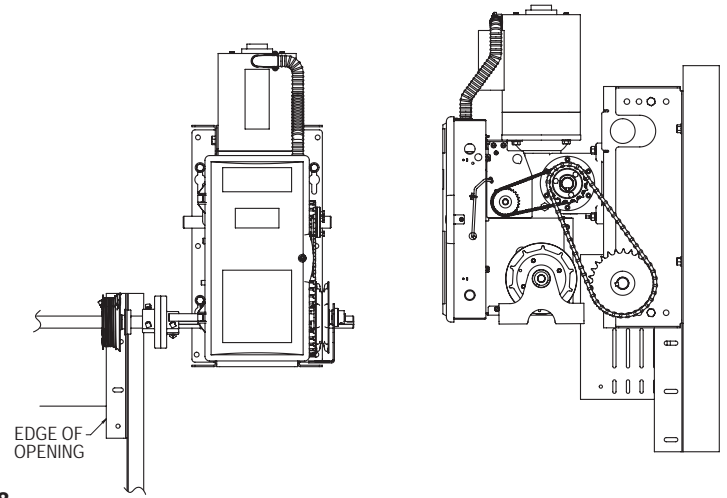

Figure 8

HP	OPTIONAL MOUNTING KIT	PART NO.
1/2, 3/4, 1	Direct Couple—26 RPM	OPMKDC26HX.S
1/2, 3/4, 1	Direct Couple—14 RPM	OPMKDC14HX.S
3	Direct Couple—14 RPM	OPMKDC14HX3HP.S

Sectional Doors

Center Mount *(With Direct Couple Kit)*

Right-Hand unit shown.

Refer to CENTER MOUNT Supplemental Instruction,
P/N 111777.500141 (Included in Center Mount Kit)

VERTICAL CENTER MOUNT

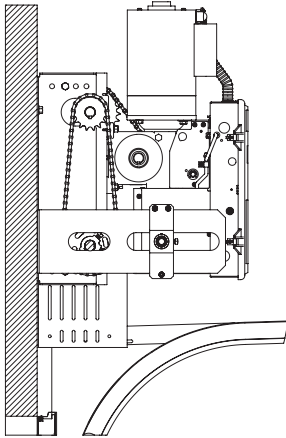

NOTES:

1. A CLEARANCE OF 8" SHOULD BE ALLOWED FOR ACCESS TO ELECTRIC BOX.
2. AVERAGE DOOR TRAVEL SPEED VARIES PER DRUM USED.
3. OPERATOR MOUNTING BRACKETS MOUNT TO WALL.

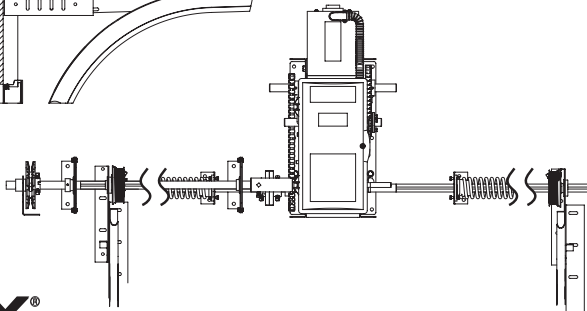

HORIZONTAL CENTER MOUNT

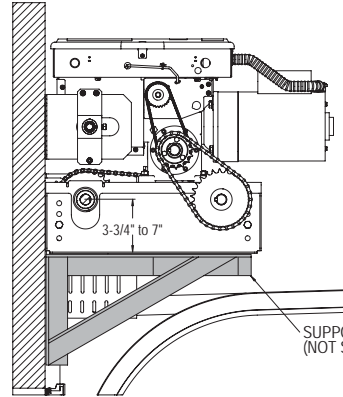

SUPPORT FRAMEWORK NEEDED
(NOT SUPPLIED)

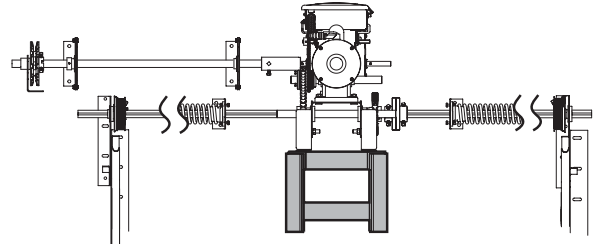

Figure 9

HP	OPTIONAL MOUNTING KIT	PART NO.
1/2, 3/4, 1	Centermount Vertical	OPMKCMVHX.S
1/2, 3/4, 1	Centermount Horizontal	OPMKCMHHX.S
3	Centermount Vertical	OPMKCMVHX3HP.S
3	Centermount Horizontal	OPMKCMHHX3HP.S

Rolling Steel Fire Doors
Various (reference only)

Refer to FIRE DOOR Supplemental Instruction, P/N 111775.500141

#4 DRIVE FRONT OF HOOD

#4 DRIVE TOP OF HOOD

#5 DRIVE FRONT OF HOOD

#5 DRIVE TOP OF HOOD

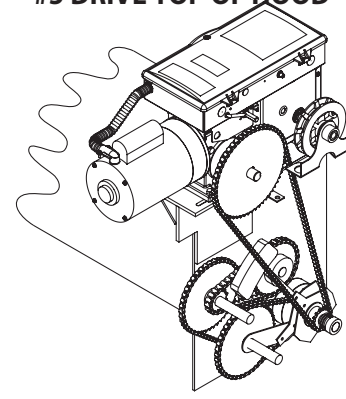
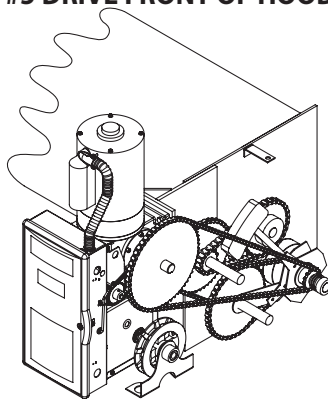
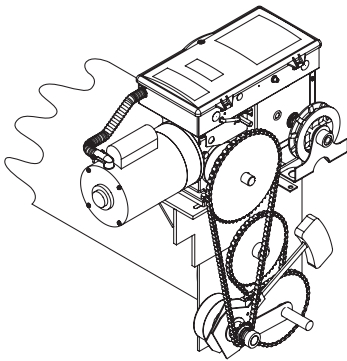
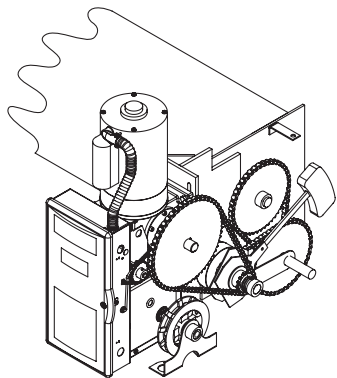

Right hand unit shown. All configurations are available in left hand versions.

Figure 10

HP	KIT	PART NO.
1/2, 3/4, 1	Fire Door Right Hand Mount Bracket	111687.0001
1/2, 3/4, 1	Fire Door Left Hand Mount Bracket	111687.0002
1/2, 3/4, 1	Handwheel Extension Kit	OPAKFDHWHX.S
1/2, 3/4, 1	Limit Extension Kit	OPAKLEHX.S

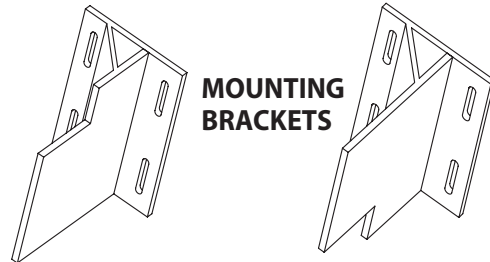

MOUNTING BRACKETS

Unpacking and Configuring Release Cord: Fig. 11

The cord comes shipped connected to the Release Lever and looped around the end of the hoist shaft opposite the handwheel, with the bulk of the cord taped to the handwheel side of the brake enclosure (SIDE A).

- 1) Untape the bulk of the cord from the side panel of brake enclosure. Straighten cord, ensuring there are no kinks or knots.
- 2) Determine which side you want the cord to be on.
 - **For use on SIDE A**, unloop cord from the SIDE B end of hoist shaft and pull it out through SIDE A hole.
 - **For use on SIDE B**, pull cord out through SIDE B hole.

Shifting Manual Handwheel SIDE A to SIDE B: Fig. 11

The release mechanism is factory installed and is designed so that it can be right or left-hand mount. To switch the handwheel:

- 1) Loosen the set screws (1) and remove set collar (2).
- 2) Slide the chain guard (3) and handwheel (4) off of hoist shaft.
- 3) Slide all onto opposite side in order shown and tighten set screws.

Figure 11

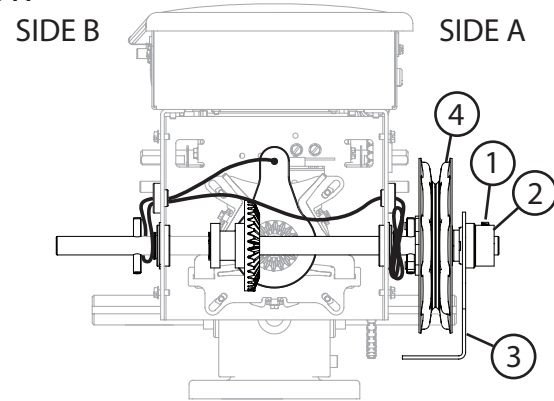

Handwheel, Chain and Keeper

- 1) Route the hand chain through the chain guide, around the pocket wheel and back through the chain guide. **Fig.12.**
- 2) Connect the hand chain ends together as shown in **Fig 13.** by twisting open the last link on one end of the chain, and slipping the last link on the opposite end onto the open link.
- 3) Twist open link closed again.
- 4) Mount chain keeper to wall in line with chain approximately 4 feet from floor.
- 5) Loop chain around keeper as shown. **Fig. 14.** Optional Padlock not provided.

NOTE: To insure smooth operation, make sure there is no twist in the hand chain before connecting the link ends together.

Figure 12

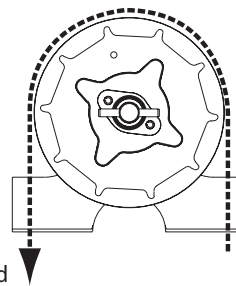

Figure 13

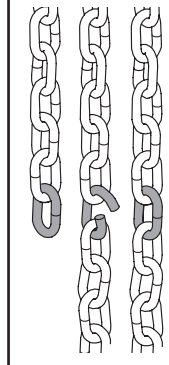
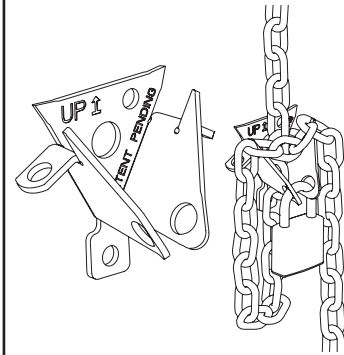

Figure 14



Adjusting the Clutch (Optional)

NOTE: The clutch is intended to provide protection for the door, operator and associated equipment. It is not intended for entrapment protection.

The RHX® Clutch does not require any disassembly to adjust.

- 1) All adjustments should be made in very small increments (e.g. turning adjustment bolts 1/4 turn per increment).
- 2) When making adjustments, be sure to turn all 3 adjustment bolts an equal amount. **Fig 16.**
 - To increase tension, turn adjustment bolts clockwise.
 - To decrease tension, turn adjustment bolts counter-clockwise.
- 3) Clutch needs to be adjusted to a tension just above what is required to open and close door without clutch slippage.

NOTE: Periodically check the system for proper clutch action. If clutch starts to slip after working properly for some time, check manual operation of door before adjusting clutch. Door may not be operating freely or counter-balance spring may need adjusting. Repairs and adjustments must be performed by a trained service representative using proper tools and instructions.

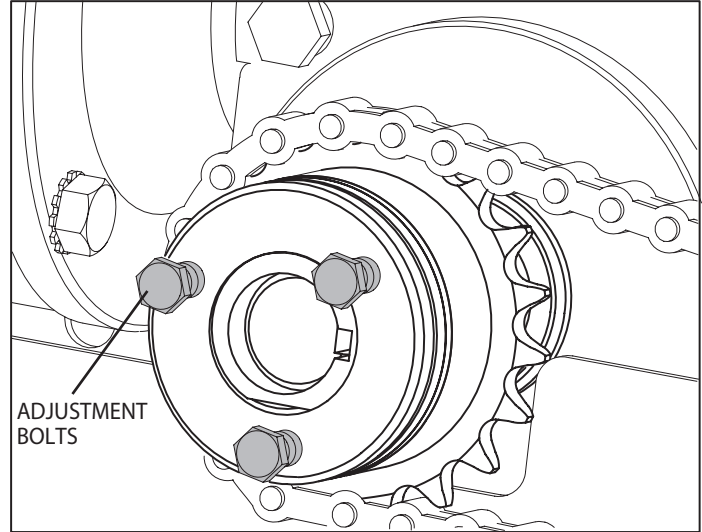

Figure 16

Section 5: Wiring

Line Voltage Wiring Fig. 1

⚠ WARNING

- DO NOT apply power to operator until instructed to do so.
- It is strongly recommended, and may be required by law in some areas, that line voltage wiring be performed by a qualified electrician.
- Be sure that electrical power has been disconnected from the input power wires being connected to the operator prior to handling these wires. An appropriate lock-out / tag-out procedure is recommended.
- Line voltage wiring must meet all local building codes.
- Make sure operator voltage, phase and frequency nameplate ratings are identical to the job site line voltage ratings.
- Input power wiring must be properly sized for the operators amperage rating located on the nameplate.
- To reduce the risk of electric shock, make sure the chassis of this unit is properly grounded.

- 1) Remove LINE VOLTAGE INPUT PLUG and install proper fittings and 1/2" conduit.
- 2) Route proper LINE VOLTAGE wires into operator.
- 3) Locate LINE INPUT terminals on circuit board. Using correct connectors, attach wires to LINE INPUTS, and GROUND terminal.
 - Keep low voltage and line voltage wires separate.
 - Route all line voltage wires as shown.
 - Plug all unused conduit holes.

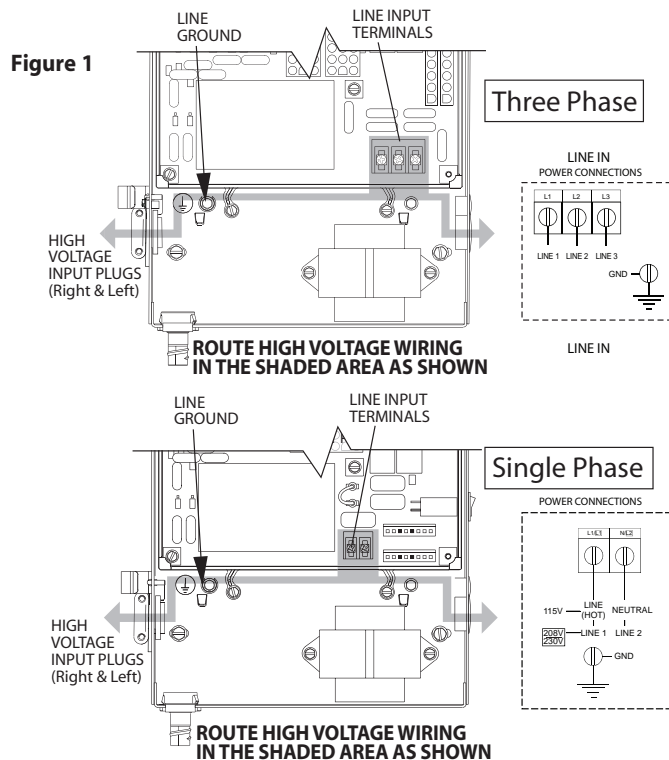

Low Voltage Control Wiring (general) Fig. 2

- 1) Connect all LOW VOLTAGE control circuit wires to this side of unit using 1/2" conduit or flexible convoluted tubing.
 - Keep low voltage and line voltage wires separate.
 - Route all low voltage control wiring as shown. This includes all control circuit wires such as wall controls, timers and single button input devices as well as radio control and safety circuit wiring. See Figs 2 through 10 in this section.
 - Plug all unused conduit holes.

NOTE: For a detailed description of control wire terminals see Appendix B.

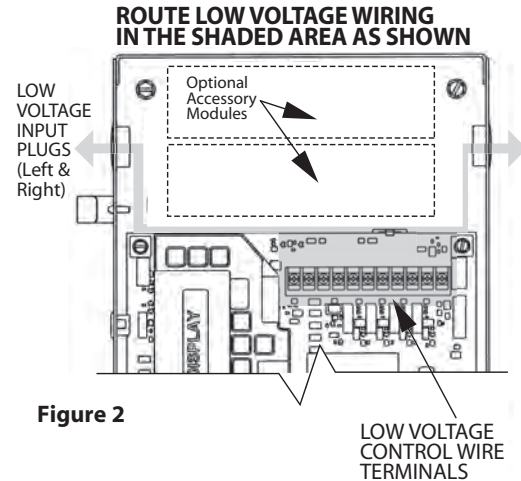

External Wire Diagram

See Appendix B for detailed description of terminals.

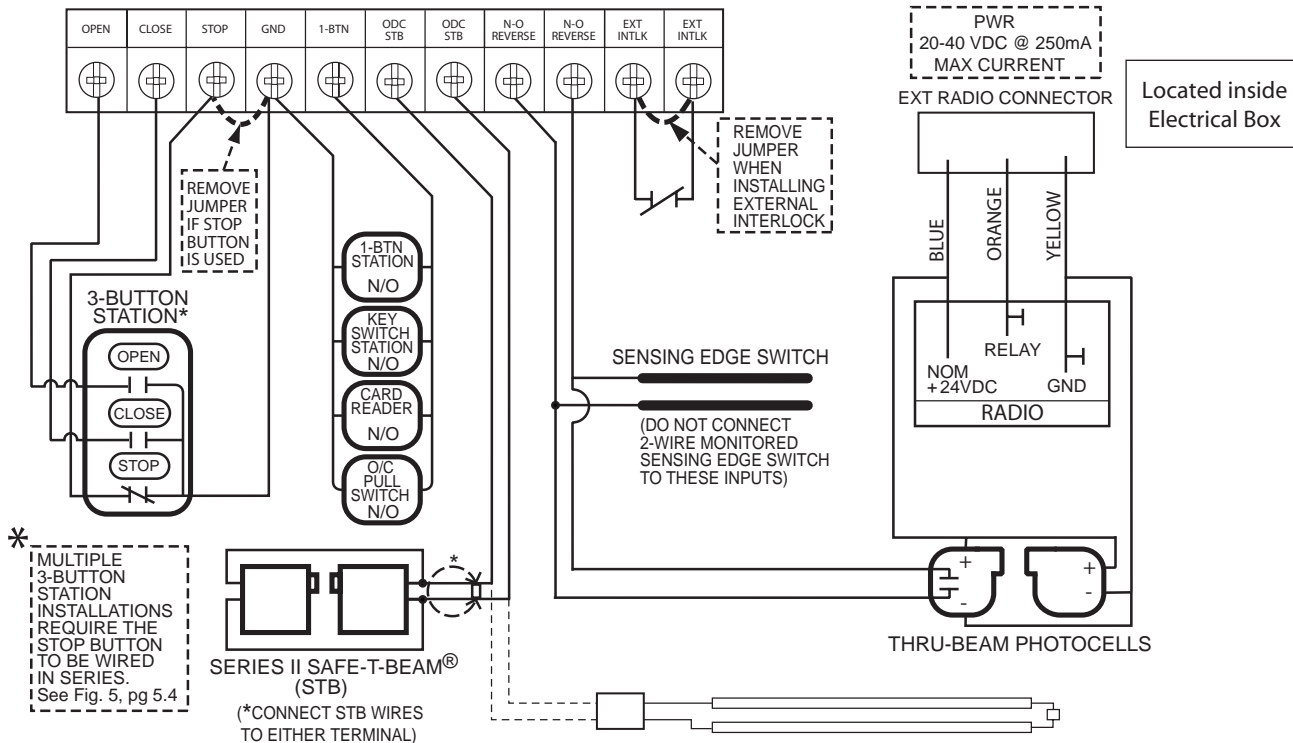

Wall Control

WARNING:

- Wall Control(s) must be located so that the door is within sight of the user.
- Attach the Warning placard adjacent to the Wall Control. **Fig. 3A.**

WARNING:

If momentary contact control is to be used, an external reversing device such as a photocell system or sensing edge switch must be used. See pages 5.6-5.7 for installation of entrapment protection devices.

- 1) For a single 3 - button installation, make connections as shown in **Fig. 3.**
- 2) For single button accessory controls, make connections as shown in **Fig. 4.**
- 3) For a multiple 3 - button installations, make connections as shown in **Fig. 5.**

NOTE: If an External STOP button is NOT being installed, a jumper wire must be installed between the "STOP" AND "GND" terminals as shown.

NOTE: Long Distance Relay Kit wiring is not required for long distance control runs and should not be used.

Figure 3

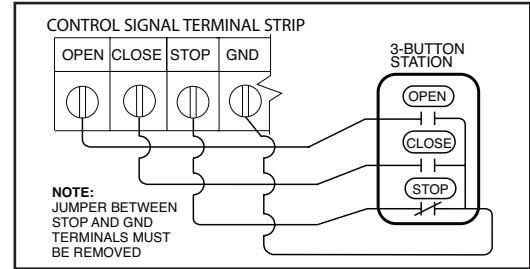
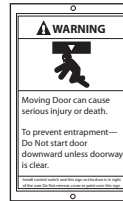

Figure 3A



Entrapment
Warning
Placard

Figure 4

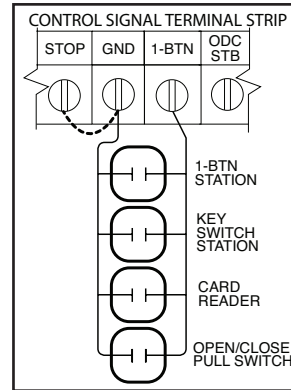
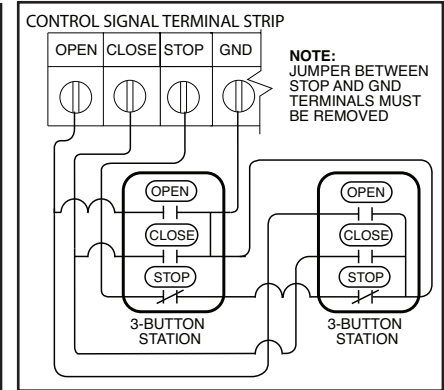
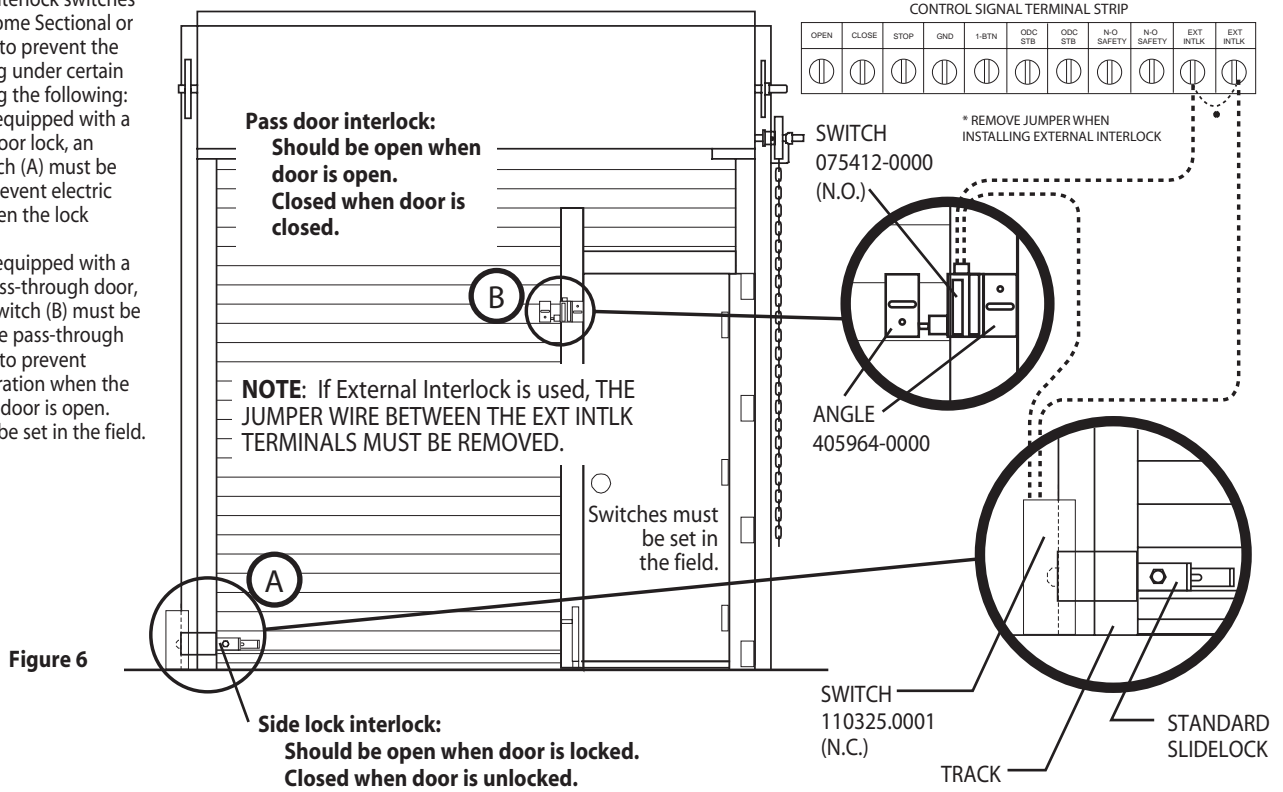

Figure 5



Interlock Switches

- 1) Optional external interlock switches are required with some Sectional or Rolling Steel Doors to prevent the door from operating under certain conditions including the following:
 - If the door is equipped with a functioning door lock, an interlock switch (A) must be installed to prevent electric operation when the lock is engaged.
 - If the door is equipped with a pedestrian pass-through door, an interlock switch (B) must be installed at the pass-through door in order to prevent electrical operation when the pass-through door is open.
- 2) The Switches must be set in the field.



Monitored Photocell Wiring

Series II Safe-T-Beam® Monitored Photocells

- 1) Monitored SERIES II (STB) photocells (P/N OPAKPE.S) can be installed as shown in **Fig. 7**. Wiring to these photocells can be connected to either terminal (they are not polarity sensitive). (**Troubleshooting in Section 8**).

NOTE: Monitored Sensing device must be installed or unit will require Constant Contact to Close.

⚠ WARNING: Actuating operator using constant contact on the CLOSE button will override external reversing devices, including photocells.

- 2) **To Mount Photocells:** (Kit includes detailed Instructions).
 - Determine location for mounting. They do not need to be directly adjacent to the door but must be somewhere along the wall where there will be an unobstructed line between them. **Fig 8**.
 - Screws provided for mounting on soft material (wood, drywall, etc.)
 - They must extend out away from the wall sufficiently that no door hardware breaks the plane of the photo-beam.

⚠ WARNING: Photocell systems provide entrapment protection when mounted near the doorway in such a way that the lower portion of an individual's leg will break the photocell beam during normal walking conditions. **Fig. 8**.

Commercial Non-Monitored Photocells

- 1) Nominal 24 Volt DC Commercial photocells with normally open contacts can be connected as shown in **Fig. 9**.

NOTE: Blue wire supplies 20 – 40VDC. Photocells used must be compatible with this voltage range.

NOTE: If no voltage is present at Blue wire, check fuse F-1 on Control board.

CONNECT WIRES TO EITHER TERMINAL
(NOT POLARITY SENSITIVE)

Figure 7

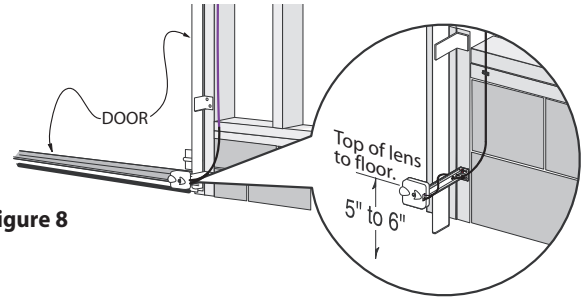
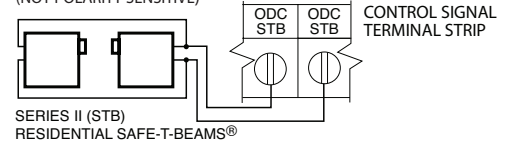

Figure 8

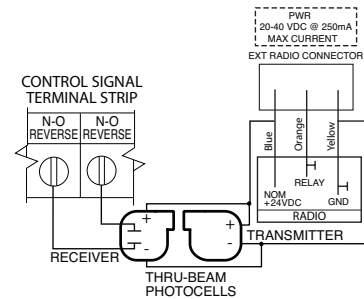

Figure 9

Sensing Edge Switch Installation

Figure 10 shows an example of a typical sensing edge installation. Left hand side is shown but right hand is a mirror image of this.

- 1A) If wiring from sensing edge switch to operator is coiled cord or 2 wire jacketed cord:
 - Install junction box 12" above the center of the door opening on same side as sensing switch.
 - Secure one end of cord to junction box using a cable clamp.
- 1B) If connection is to be made through a take up reel cord:
 - Install on same side as sensing edge switch and above door opening and slightly to the side.
 - Install junction box adjacent to take up reel and route the stationary cord from the reel to the box and secure with a cable clamp.
- 2) Secure other end of cord (straight, coiled or reel) to sensing edge switch enclosure using a cable clamp.
- 3) Connect wires of cord to sensing edge switch using wire nuts or other suitable wire connectors.
- 4) Run a straight 2 wire cord from the junction box (Step 1) to the operator electrical box.
 - Secure using cable clamp on each end.
- 5) Join wires in cord from operator to wires in cord from switch using wire nuts or other suitable wire connectors.
- 6A) **Non-monitored** sensing or reversing edge connects to terminal strip using N-O Safety inputs. See **Fig. 11A**.
- 6B) **Monitored** sensing or reversing edge connects Timer-Close Module terminals as shown in **Fig. 11B**.
- 7) Operate the door to make certain cord is free to travel and does not become snared during door opening or closing.
 - Check sensing edge switch for proper operation.

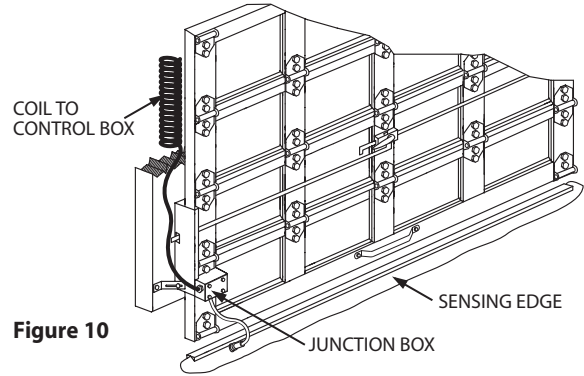

Figure 10

Figure 11A

NOTE: Do not connect a 2-wire monitored sensing edge switch to these terminals.

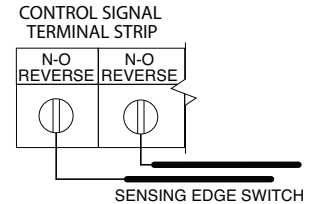
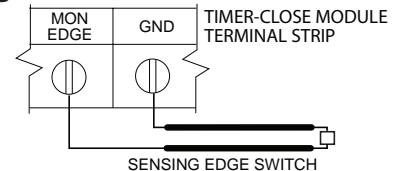

Figure 11B

NOTE: Monitored 2-wire sensing or reversing edge can only be used in combination with a Timer-Close Module.



WARNING: Actuating the operator using constant contact on the CLOSE button will override external reversing devices, including sensing edges or reversing edges.

External Radio Installation

Although the RHX® Operators are equipped with an internal radio, they also provide a universal connection for an external radio.

To Add the External Radio

- 1) Plug the pigtail with the 3 wires attached (provided) onto the plug connector marked "EXT RAD." **Fig. 12.**
- 2) Make wiring connections to the wires per the diagram below.

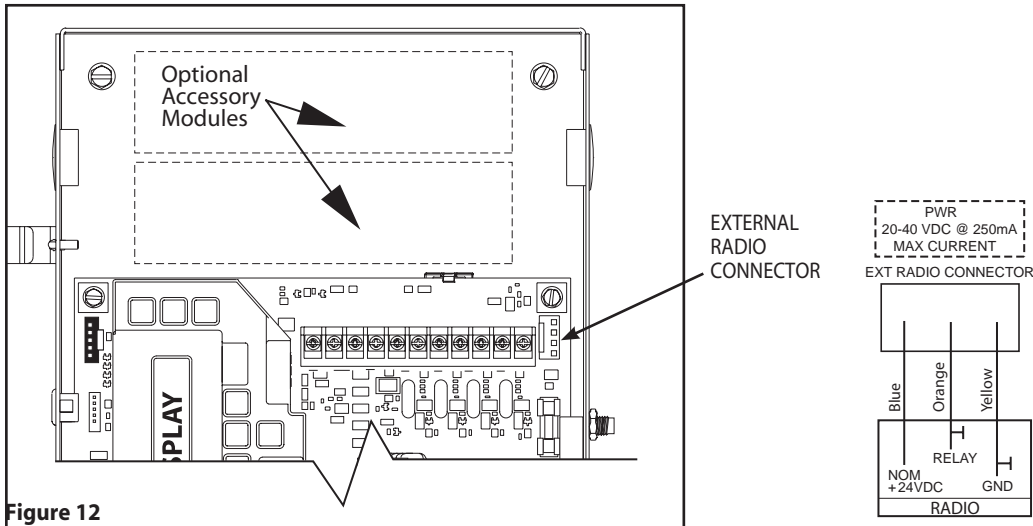

Figure 12

⚠ WARNING:

Verify Line Voltage before making any connections to assure that motor harness is connected to proper motor connector on circuit board.

- 1) Plug motor harness into proper motor connector on circuit board in electric box. **Fig. 13.**
- 2) Apply primary power.

Figure 13

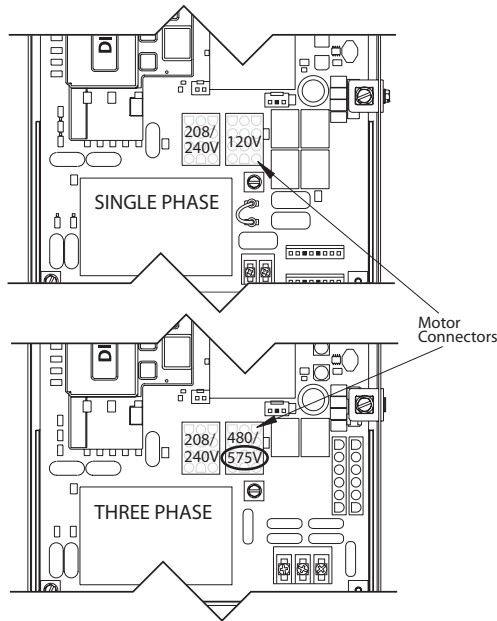

IMPORTANT SAFETY INSTRUCTIONS

WARNING -

To reduce the risk of severe injury or death:

- 1) READ AND FOLLOW ALL INSTRUCTIONS.
- 2) Never let children operate or play with door controls. Keep the remote control (where provided) away from children.
- 3) Personnel should keep away from a door in motion and keep the moving door in sight until it is completely closed or opened. **NO ONE SHOULD CROSS THE PATH OF A MOVING DOOR.**
- 4) Test the door's safety features at least once a month. After adjusting either the force or the limit of travel, retest the door operator's safety features.
- 5) For products having a manual release, if possible, use the manual release only when the door is closed. Use caution when operating the release while the door is open. Weak or broken springs may cause the door to fall rapidly, causing severe injury or death.
- 6) **KEEP DOOR PROPERLY OPERATING AND BALANCED.** See Door Manufacturer's Owner's Manual. An improperly operating or improperly balanced door could cause severe injury or death. Have only trained door systems technicians make repairs to cables, spring assemblies and other hardware.
- 7) **SAVE THESE INSTRUCTIONS.**

⚠ DANGER: After power is supplied to the operator, **Do Not** make contact with components inside the control panel except for the Keypad Keys. **Fig. 1.**

Section 6: Operator Setup Procedure

Control Panel

RHX® Operators include a full function control panel including a liquid crystal display (LCD), calibration keys and Open, Close and Stop keys for on board operator control. See **Fig. 1**. The open, close and stop keys function as a 3-button wall control. The Display will show current operator conditions and calibration information. Due to limited character space, some displays will be abbreviated. See Appendix C (pgs. 10.9-10.11) for full display descriptions.

RHX® Operators include a non-volatile memory. The unit will remember all calibration settings plus error code and run code logs, if power is removed from unit.

⚠ DANGER: After power is supplied to the operator, **Do Not** make contact with components inside the control panel except for the Keypad Keys. **Fig. 1**.

TURN ON POWER TO OPERATOR

Control Operating Modes

RHX® Operator control boards operate in two modes: Run Mode and Calibration Mode. The control board should normally operate in the Run Mode. The operator is calibrated in Calibration Mode.

With the operator standing idle:

PRESS CAL/RUN TO TOGGLE BETWEEN OPERATING MODES.

- The first display in calibration mode is "set close dir."
- The display in run mode will be one of the condition codes listed in Appendix D.

⚠ WARNING: DO NOT calibrate operator or operate door unless doorway is in sight and free of obstructions. Door will move during setup. Keep people clear of opening while door is moving.

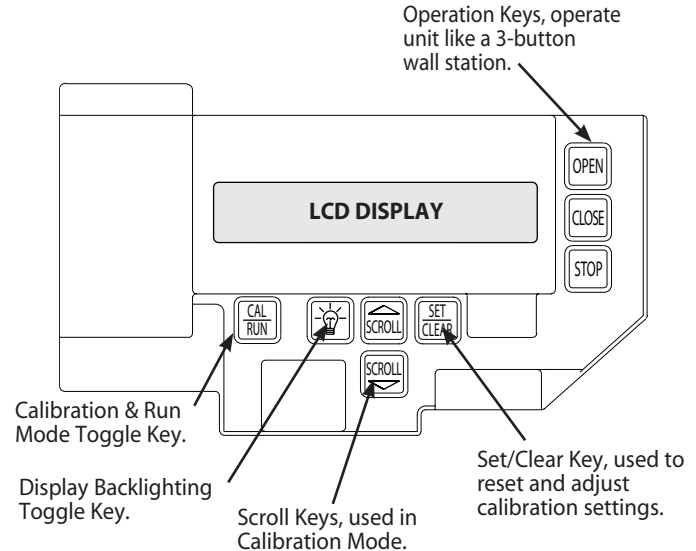

Figure 1

Setting Close Direction

The direction of motor rotation depends on mounting position and/or how the main input power phases are wired. This setting is used to insure the door is closing and opening according to the input commands.







- 1) If operator is in RUN mode, press CAL/RUN  to enter calibration mode.
- 2) Press SET/CLEAR  to begin the calibration procedure and advance to the next screen. **Figure 3.**
- 3) Briefly press the CLOSE  key. (Pressing the Scroll key at this point will exit this control function.)
 - The display will read “ DID DOOR CLOSE? ” **Figure 4.**
- 4) Press SCROLL  key (up or down) to toggle between YES and NO. **Figure 5.**
 - If YES is selected, no change to operator calibration is made. If NO is selected — the POD will change the operator’s down direction.
- 5) Press the SET/CLEAR  key.
- 6) Press CAL/RUN  to return to run mode.

Figure 2

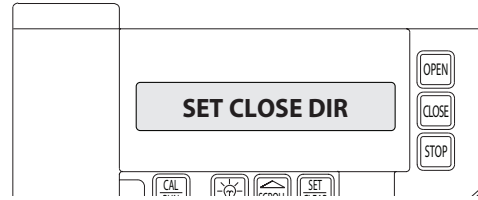

Figure 3

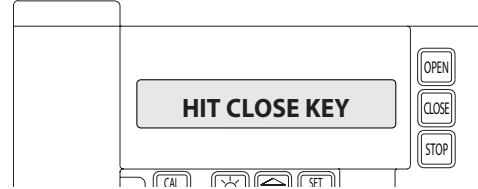
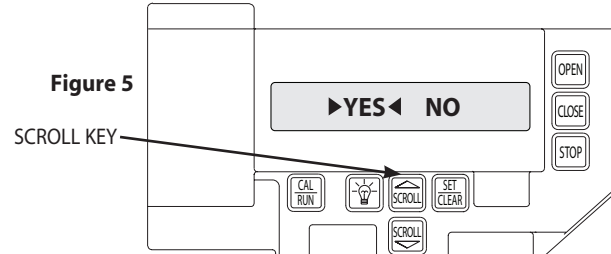





Figure 4



Figure 5



Setting Braking Rate

- 1) If operator is in RUN mode, press CAL/RUN  to enter calibration mode.
- 2) Press Scroll until display reads "BRAKING RATE >#," where # is the deceleration rate, ranging from 0 to 9. 0 = MAX braking, 9 = MIN braking. **Figure 6.**
- 3) Press SET/CLEAR  key to toggle between 0 and 9—one digit at a time.
- 4) Pick a value and operate the door. Adjust as necessary.
- 5) Press a SCROLL  key to shift to a new function and lock in the setting.
- 6) Press CAL/RUN  to return to run mode.

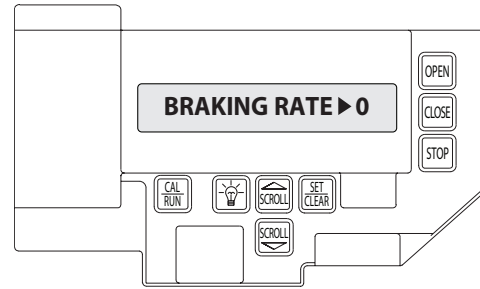









Figure 6







Setting Travel Limits

UP and/or DOWN

- 1) If operator is in RUN mode, press CAL/RUN  to enter calibration mode.
- 2) Press SCROLL  until display reads "UP LIMIT>CLR " or "DOWN LIMIT>CLR " **Figure 7.**
- 3) Jog the door using the OPEN  or CLOSE  key until you reach the desired height.
- 4) Press SET/CLEAR  key to switch display to "UP LIMIT>SET " or "DOWN LIMIT>SET ." **Figure 8.**
- 5) Press a SCROLL  key to shift to a new function and lock in the limit setting.
- 6) Press CAL/RUN  to return to run mode.

Resetting Travel Limits

UP and/or DOWN

- 1) If operator is in RUN mode, press CAL/RUN  to enter calibration mode.
- 2) Press SCROLL  until display reads "UP LIMIT>SET " or "DOWN LIMIT>SET." **Figure 8.**
- 3) Press SET/CLEAR  to switch display to "UP LIMIT>CLR " or "DOWN LIMIT>CLR"
- 4) Jog the door using the OPEN  or CLOSE  key until you reach the desired height.
- 5) Press SET/CLEAR  to switch display to "UP LIMIT>SET" or "DOWN LIMIT>SET"
- 6) Press CAL/RUN  to return to run mode.

NOTE: The recommended setpoint for the DOWN Travel Limit is normally at approximately 2 inches off the floor. This final distance will be covered by the Limit Overrun Function to establish a more accurate seal.

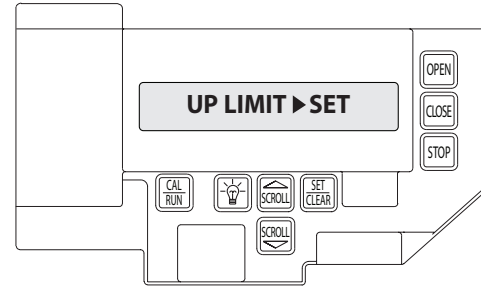

Figure 7

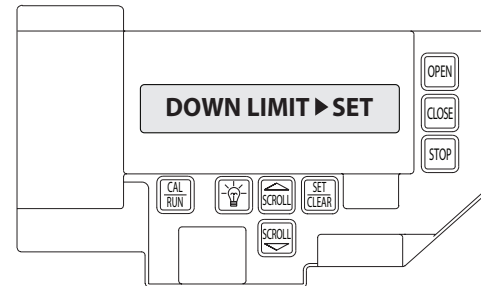

Figure 8

ALTERNATE METHOD FOR REMOTELY SETTING ALL LIMITS.

This method will not clear or change an already set limit. To use this method you must first clear the existing limit setpoint.

- 1) Using the OPEN, CLOSE, STOP buttons on the Wall Station, place the door in the desired position for the limit you wish to set (UP, DOWN or MID-STOP).
- 2) With the door stopped and in desired position:
 - Press and hold the STOP button for, at least 10 seconds. **DO NOT press any other button.**

NOTE: Following the setting of a limit you will hear the operator move for a split second as it confirms the setting.

- 3) While still holding the STOP button:
 - To set the **Up Limit**
 - a. Press and hold the OPEN button for one second.
 - b. Release the STOP button, then release the OPEN button.
 - To set the **Down Limit**
 - a. Press and hold the CLOSE button for one second.
 - b. Release the STOP button, then release the CLOSE button.
 - To set the **Mid-Stop Limit**
 - a. Press and hold **both** OPEN and CLOSE buttons for one second.
 - b. Release the STOP button, then release the OPEN and CLOSE buttons.

This procedure will work with the Cal Pod (keypad) in either CAL or RUN mode.

This procedure was specifically designed to prevent the accidental altering of a limit through normal use or a faulty button or wiring.

Setting Down Limit Overrun

This Setting is a matter of trial and Error





- 1) If operator is in RUN mode, press CAL/RUN  to enter calibration mode.
- 2) Press SCROLL  until display reads “DN LM OVERRUN>#” where # is the increment of travel beyond the CLOSE Limit ranging from 0 to 9. Zero turns off the Overrun function and the door stops at the DOWN Limit. Nine is the maximum distance the door will travel past the limit. This function is used to insure a good seal at the bottom of the door.

Figure 10.

- 3) Press SET/CLEAR  key to toggle between 0 and 9—one digit at a time.
- 4) Pick a value and operate the door. Adjust as necessary.
- 5) Press a SCROLL  key to shift to a new function and lock in the setting.
- 6) Press CAL/RUN  to return to run mode.

NOTE: The actual distance that the Overrun function covers is variable depending on model of operator and size of the door (nominally about 2 inches of travel).

⚠ WARNING: The DOWN Limit Overrun function will override external reversing devices, including photo cells and sensing or reversing edges. Therefore, any externally connected devices will be disabled during that portion of door travel which is controlled by the Limit Overrun function.

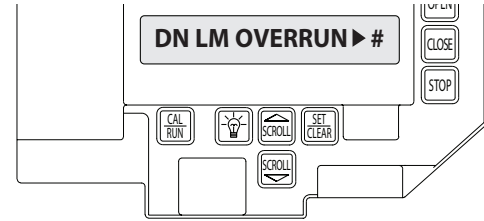















Figure 9

Setting Open and Close Modes (Constant vs Momentary Contact)

OPEN

- 1) If operator is in RUN mode, press CAL/RUN  to enter calibration mode.
- 2) Press SCROLL  until display reads "OPEN MODE>MOM" or "OPEN MODE>C-STP." **Figure 10.**
 - MOM=momentary contact, meaning you **press and release** the OPEN  or CLOSE  key and **the door will continue to move** until it reaches its travel limit. (See NOTE)
 - C-STP=constant contact-stop, meaning **if you release the key** prior to the door reaching its travel limit, **the door will stop.**
- 3) Press SET/CLEAR  key to toggle between "OPEN MODE>C-STP" or "OPEN MODE>MOM" on the display.
- 4) Press a SCROLL  key to shift to a new function and lock in the setting.
- 5) Press CAL/RUN  to return to run mode.

CLOSE

- 1) If operator is in RUN mode, press CAL/RUN  to enter calibration mode.
- 2) Press SCROLL  until display reads "CLOSE MODE>MOM," "CLOSE MODE>C-STP" or "CLOSE MODE>C-REV." **Figure 10.**
 - MOM=momentary contact, meaning you **press and release** the OPEN  or CLOSE  key and **the door will continue to move** until it reaches its travel limit. (See NOTE)
 - C-STP=constant contact-stop, meaning **if you release the key** prior to the door reaching its travel limit, **the door will stop.**
 - C-REV=constant contact-reverse, meaning **if you release the key** prior to the door reaching its travel limit, **the door will reverse direction.** (See NOTE)
- 3) Press SET/CLEAR  key to toggle between "CLOSE MODE>C-STP" or "CLOSE MODE>C-REV" or "CLOSE MODE>MOM" on the display.
- 4) Press a SCROLL  key to shift to a new function and lock in the setting.
- 5) Press CAL/RUN  to return to run mode.

NOTE: Momentary contact (**MOM**) or Constant Reverse (**C-REV**) may not be used unless both the OPEN and CLOSE Limits have been set.

In situations where an external reversing device is either not installed or not operating properly, Constant Contact (**C-STP**) MUST BE USED.

⚠ WARNING: Before momentary contact control can be used, an external reversing device such as a photocell system or sensing edge switch must be used. See pages 5.6-5.7 for installation of entrapment protection devices.

NOTE: During adjustment of a Travel Limit, the Open and Close Modes will automatically fail-safe to Constant Contact until the Limit has been set or reset. At that time the Open and Close Modes will revert to their previous setting.

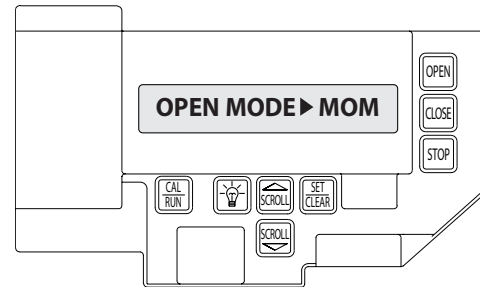







Figure 10

(Optional) Transmitter Programming

Adding a Transmitter

- 1) If operator is in RUN mode, press CAL/RUN  to enter calibration mode.
- 2) Press SCROLL  (up or down) until display reads "LEARN NEW XMTR?" **Figure 11.**
 - This question along with the instruction "HIT SET FOR YES" will continuously pan across the display window. (Pressing SCROLL or RUN/CAL will cancel the operation.)
- 3) Press SET 
 - Display will read "PUSH XMTR BUTTON TWO TIMES TO LEARN XMTR."
- 4) Press Transmitter button two times.
 - The display will read "XMTR ___ LEARNED." Where it assigns a random number between 1 and 255 to the transmitter. That transmitter is entered and ready to operate the door. (Label/mark the transmitter.)
- 5) Press SCROLL  (up or down) to move on to another menu item, or CAL/RUN  to exit the CAL mode.

Removing Individual Transmitter







- 1) If operator is in RUN mode, press CAL/RUN  to enter calibration mode.
- 2) Press SCROLL  (up or down) until display reads "REMOVE XMTR?" **Figure 12.**
 - This question along with the instruction "HIT SET FOR YES" will continuously pan across the display window. (Pressing SCROLL or CAL/RUN will cancel the operation.)
- 3) Press SET 
 - A menu displaying the available transmitter numbers will appear. Press SCROLL  (up or down) to cycle through the menu to the number of the transmitter to be removed. (Pressing CAL/RUN will cancel the operation.)
- 4) Press SET 
 - The transmitter is removed.
- 5) Press SCROLL  (up or down) to move on to another menu item, or CAL/RUN  to exit the CAL mode.



Figure 11









Figure 12



Figure 13



Removing All Transmitters

- 1) If operator is in RUN mode, press CAL/RUN  to enter calibration mode.
- 2) Press SCROLL  (up or down) until display reads "REMOVE ALL XMTRS" **Figure 13.**
 - This question along with the instruction "HIT SET FOR YES" will continuously pan across the display window. (Pressing SCROLL or CAL/RUN will cancel the operation.)
- 3) Press the SET  key.
 - The display will read "ARE YOU SURE."
- 4) Press the SET  key.
 - All transmitters are removed.
- 5) Press SCROLL  (up or down) to move on to another menu item, or CAL/RUN  to exit the cal mode.



Optional Mid-Stop Limit Setting

The RHX® Operator includes a programmable Mid-Stop. This feature allows the operator to stop at a user selectable point when opening. It is used when operating very tall doors that only open to their full height occasionally. The Mid-Stop does not effect the operator when closing. To operate door to full open position from mid-stop, press open button again.





NOTE: Setting of the MID-STOP should only be performed AFTER Travel Limits have been set and door has been cycled fully open and then fully closed.

- 1) Press CAL/RUN  to enter calibration mode.
- 2) Press the CLOSE  to close the door to the down limit.
- 3) Press SCROLL  until display reads "MID-STOP >CLR" **Figure 14**.

NOTE: If the display reads MID-STOP > SET at this point, first clear the MID-STOP as described below then repeat steps 1-3 and continue.

- 4) Press the OPEN  to open the door to desired mid-stop height.
- 5) Press SET/CLEAR  until the display reads "MID-STOP > SET"
- 6) Press CAL/RUN  to return to run mode.

To CLEAR the Limit

- 1) Press CAL/RUN  to enter calibration mode.
- 3) Press SCROLL  until display reads "MID-STOP >SET"
- 5) Press SET/CLEAR  until the display reads "MID-STOP > CLR"
- 8) Press CAL/RUN  to return to run mode.

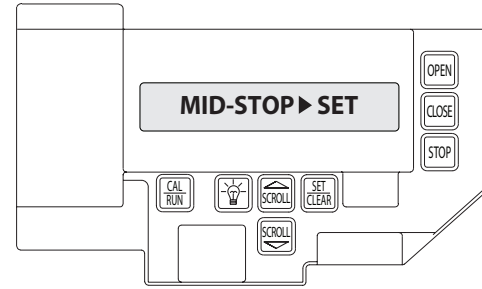







Figure 14

**AN ALTERNATE METHOD FOR SETTING LIMITS
USING THE WALL BUTTONS IS ON PAGE 6.5**

Monitored Reversing Devices

ODC Safe-T-Beams® (OPTIONAL)

- 1) If operator is in RUN mode, press CAL/RUN  to enter calibration mode.
- 2) Press SCROLL  (up or down) until display reads "ODC STB>ON" or "ODC STB>OFF" **Figure 15**.
- 3) Press SET/CLEAR  key to toggle between ON and OFF.
- 4) Press SCROLL  (up or down) to shift to a new function and lock setting.
- 5) Press CAL/RUN  to return to run mode.

⚠ WARNING: Photocell systems provide entrapment protection when mounted near the doorway in such a way that the lower portion of an individual's leg will break the photocell beam during normal walking through the doorway. If an alternative mounting location is chosen, it must be approved by the facility owner.

Current UL Approved Monitored Reversing Devices

- 1) MillerEdge ME series model edge sensors
- 2) Overhead Door Photocells Kit P/N OPAKPE.S
(Replacement Transmitters-P/N 35046R, Receivers-35047R)
- 3) Retail type Safe-T-Beams® model GSTB-BX P/N 37220R (Genie)
model OSTB-BX P/N 37221R (OHD)

NOTE: Installation of Series II Monitored Photocells DOES NOT make the RHX® unit legal for residential use. The Overhead Door Corporation strictly prohibits any installation of an RHX® unit in any residentially zoned construction.

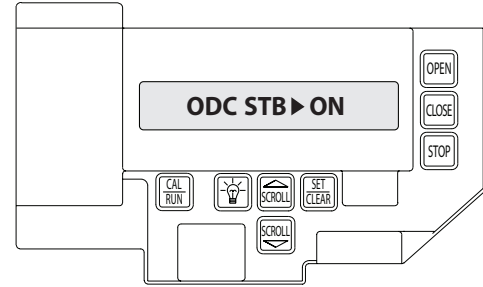



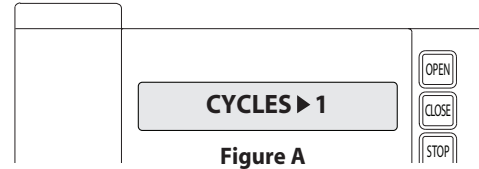

Figure 15



Section 7: Special Operator Features (No user input)

Operator Cycle Count

- 1) Press CAL/RUN  to enter calibration mode.
- 2) Press SCROLL  until display reads "CYCLES>1,2,3 etc. where the number is the number of open/close cycles the operator has performed. **Figure A.**
- 3) Press CAL/RUN  to return to run mode.



GDO and Display Firmware



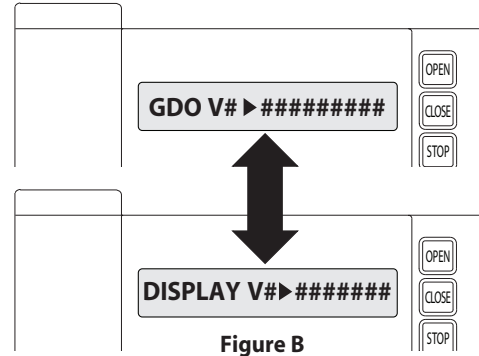

- 1) Press CAL/RUN  to enter calibration mode.
- 2) Press SCROLL  until display reads "GDO V# > #####." **Figure B.** This display will cycle between the version number of the current GDO firmware and the current Display Firmware.
- 3) Press CAL/RUN  to return to run mode.



Operator Type Fig. 3

RHX® operators are available for use in jackshaft or trolley configurations. The same control board is used for either configuration, however the control board must be set for the appropriate GDO configuration. A board set for trolley mode will not work in a jackshaft operator and vice-versa.

NOTE: The GDO type is factory set. The installer should not have to set this feature. However, if the GDO type is inadvertently changed, or if a board needs to be replaced in the field, follow these instructions to set GDO type.

- 1) Press CAL/RUN  to enter calibration mode.
- 2) Press SCROLL  until display reads "GDO TYPE > ."
This will display the current GDO type.
- 3) Press SET/CLEAR  until display indicates correct GDO type (J-SHAFT or TROLLEY)
- 4) Press CAL/RUN  to return to run mode.

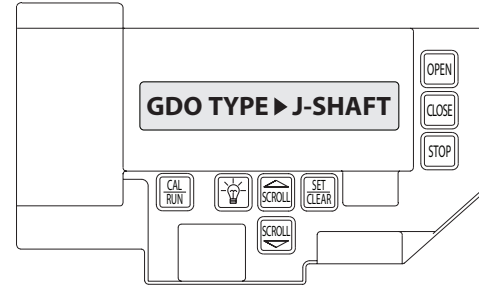

Figure 3

Section 8: Troubleshooting

Display Operation in Run Mode

RHX® operators display their status on the integrated display. Each time the operator runs, stops, reverses or refuses to run, the display will indicate why the action did, or did not, take place.

Once an error code has been generated, the RHX® operator will continue to display the error code while the operator is not running. This error code can be cleared by pressing the STOP button or STOP key on the keypad. The error code will automatically clear when the operator stops at the down limit. Error codes will continue to be stored in the RHX® operator's Error Code Memory after they have been cleared from the display in the Run Mode.

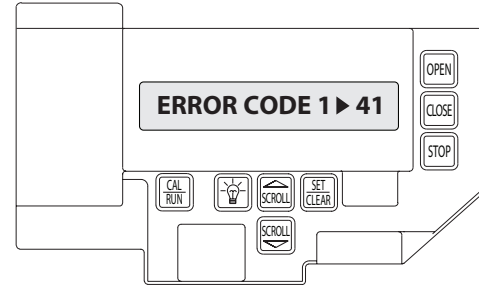

Figure 1

Error Codes

To aid in troubleshooting problems, RHX® operators include an error code memory that stores the last 10 error events. These codes are stored with or without power. The last error code detected is also displayed on the LCD until the stop button or key is pressed or the operator stops at the down limit.

The error code memory stores the last 10 error codes in sequence. Once 10 codes are stored, the oldest code is erased to make room for the newest code. These codes are displayed in calibration mode. The display will flash the number of the error code and the 2-digit error code followed by a description of the error code. **Fig. 1 & 2.**

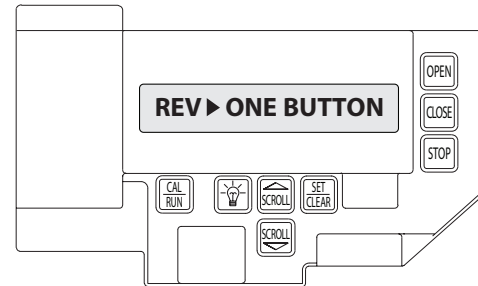





Figure 2

Error Codes (continued)

To view the error code memory:

- 1) Press CAL/RUN  to enter calibration mode.
- 2) Press SCROLL  until display reads "ERROR CODE 1 >".
 - The display will begin flashing the error code number and 2-digit error code followed by its description.
 - Reminder: Error code number 1 is the latest code generated.
- 3) Press SET/CLEAR . The display will now read "ERROR CODE 2 > ." (This is the error code which was generated before error code 1.)
- 4) Repeat step 3 until all 10 error codes have been displayed or move on to step 5 when ready.
- 5) Press CAL/RUN  to return to run mode.

NOTE: For all error codes see Appendix C, Sections 10.11 - 10.12.

Run Codes

RHX® operators also include a run code memory that stores the last 10 run events. These codes are stored with or without power. Each time the operator runs or stops, it generates a code that it stores in this memory (Why the operator ran or stopped). Used together with the error code memory, it becomes a powerful troubleshooting aid.

The run code memory stores the last 10 codes in sequence. Once 10 codes are stored, the oldest code is erased to make room for the newest code. These codes are displayed in calibration mode. The display will flash the number of the run code and the 2-digit run code followed by a description of the run code. **Fig. 3 & 4.**

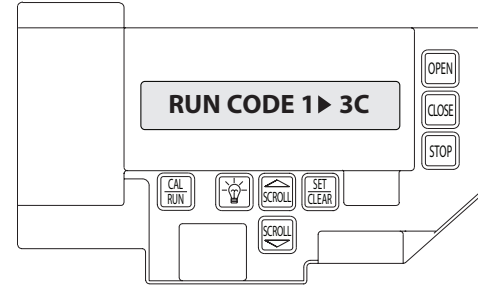

Figure 3

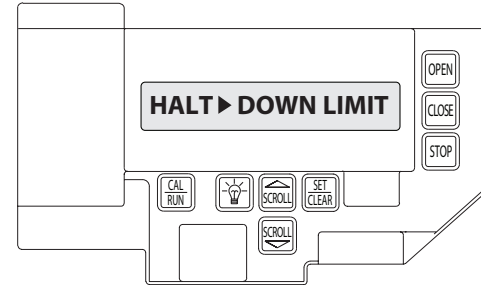





Figure 4

Run Codes (continued)

To view the run code memory:

- 1) Press CAL/RUN  to enter calibration mode.
- 2) Press SCROLL  until display reads "RUN CODE 1 > ."
 - The display will begin flashing the run code number and code followed by its description.
 - Remember: run code number 1 is the latest code generated.
- 3) Press SET/CLEAR . The display will now read "RUN CODE 2 > ."
 (This is the run code which was generated before run code 1.)
- 4) Repeat step 3 until all 10 run codes have been displayed or move on to step 5 when ready.
- 5) Press CAL/RUN  to return to run mode.

NOTE: For all run codes see Appendix C, Section 10.10.

TROUBLESHOOTING EXAMPLE USING RUN AND ERROR CODE MEMORIES. Fig. 5

1. In Calibration Mode, display and write down each Run Code and Error Code stored in memory.
2. List as shown in Fig. 5.
3. Refer to Appendix C to interpret the codes.

In this example, the operator was opened using the OPEN key on the keypad and stopped at the up limit. The OPEN wall button was then activated, causing the "6D" code to be generated since the operator could not open when it is already at the up limit. The CLOSE wall button was then activated, causing the operator to close. While closing, the Normally-Open (N-O) Safety Input was activated, causing the operator to stop and then reverse, stopping at the up limit.

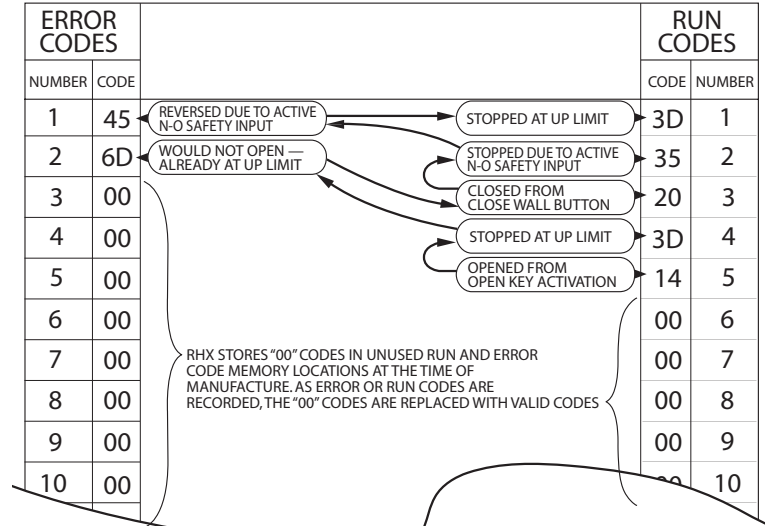
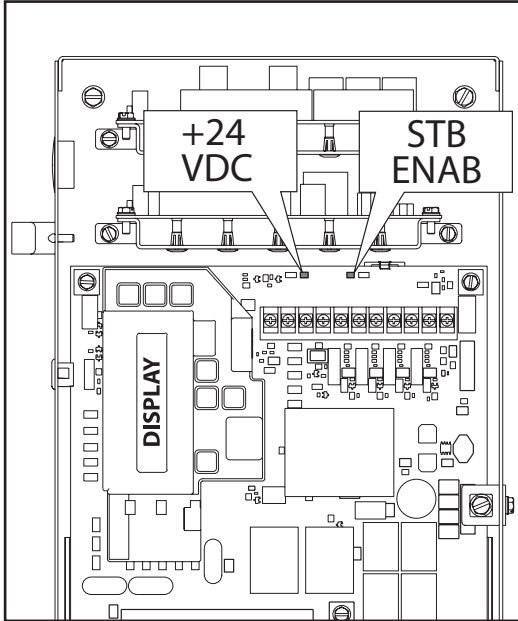

Figure 5

LED Indicators Fig. 6

RHX® operators include a self-diagnostic circuit board using troubleshooting LED indicators to signal the technician of a problem.

Figure 6



TROUBLESHOOTING LED's

STB ENABLE	NORMALLY ON - STB ENABLED	OFF - STB DISABLED
+ 24 VOLTS DC	NORMALLY ON - POWER AVAILABLE	OFF - CHECK AC POWER SUPPLY CHECK FUSES

Safe-T-Beam® Monitored Photocell Self-diagnostic Troubleshooting Chart

SOURCE (RED LED)	SENSOR (GREEN LED)	INDICATED CONDITION	REQUIRED ACTION
● ON	● ON	NORMAL OPERATION	NONE REQUIRED
○ OFF	○ OFF	1. POWER HEAD NOT POWERED 2. WIRING FROM POWER HEAD BAD	1. CHECK BREAKERS, FUSES, PLUGS 2. CHECK WIRING FOR OBVIOUS SHORTS
○ OFF	● ON	1. WIRING TO SOURCE MISSING OR BAD 2. POWER HAS BEEN INTERRUPTED	1. CHECK WIRING 2. REMOVE POWER AND REAPPLY
2 BLINKS, PAUSE (REPEAT)	● ON	1. BEAM NOT ALIGNED 2. BEAM OBSTRUCTED 3. SENSOR DEFECTIVE	1. CHECK ALIGNMENT 2. CHECK FOR OBSTRUCTION 3. CALL CUSTOMER SERVICE
2 BLINKS, PAUSE (REPEAT)	○ OFF	1. WIRE TO SENSOR MISSING OR BAD 2. SENSOR DEFECTIVE	1. CHECK WIRING 2. CALL CUSTOMER SERVICE
3 BLINKS, PAUSE (REPEAT)	● ON	1. SENSOR RECEIVING INTERFERENCE	1. ATTEMPT TO DETERMINE SOURCE OF INTERFERENCE 2. CALL CUSTOMER SERVICE
4 BLINKS, PAUSE (REPEAT)	● ON	1. SOURCE NOT SENDING PULSES 2. SOURCE DEFECTIVE	1. CALL CUSTOMER SERVICE 2. CALL CUSTOMER SERVICE

⚠ WARNING: ACTUATING THE OPERATOR BY USING CONSTANT CONTACT ON THE CLOSE BUTTON WILL OVERRIDE EXTERNAL REVERSING DEVICES, INCLUDING PHOTOCELLS.

⚠ WARNING: OVERHEAD DOOR CORPORATION RECOMMENDS THAT LINE VOLTAGE WIRING BE PERFORMED BY A QUALIFIED ELECTRICIAN. SEE SECTION 5 FOR ADDITIONAL WIRING INSTRUCTIONS.

Section 9: Service and Maintenance

Maintenance Schedule

The following table provides a schedule of recommended Service and Maintenance items to be completed by a trained service representative.

⚠ CAUTION: Failure to perform the recommended Service & Maintenance may result in premature failure of the operator.

SERVICE ITEM	SERVICE INTERVAL (FREQUENCY)			
	MONTHLY	EVERY 6 MO. OR 5,000 CYCLES	EVERY 12 MO. OR 10,000 CYCLES	EVERY 36 MO. OR 30,000 CYCLE
MANUAL OPERATION OF DOOR		●		
* PHOTOCELL/ SENSING EDGE OPERATION	●			
CLUTCH ADJUSTMENT			●	
CHECK FOR LOSE OR MISSING HARDWARE			●	
CHECK LIMIT POSITION				●
GEAR TRAIN WEAR				●

* If Installed.

Section 10: Appendix A

Operator Parts Breakdown One HP

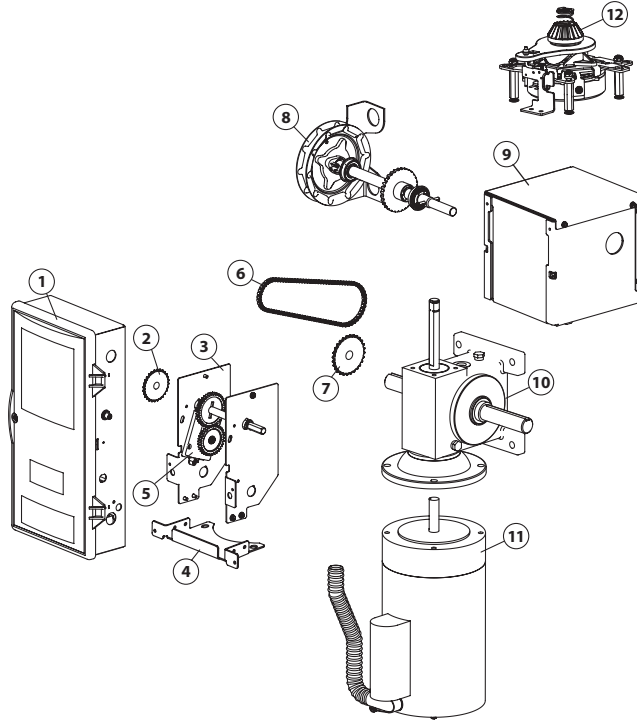

Item	Part Number	Description	Qty
	111587.0001	OPER ASSY, RHXH, 3HP	
1	111858.0001	ELEC BOX, 1/2HP, 1 PH	1
	111858.0002	ELEC BOX, 3/4HP, 1 PH	1
	111858.0003	ELEC BOX, 1HP, 1 PH	1
	111858.0004	ELEC BOX, 1/2HP, 3 PH	1
	111858.0005	ELEC BOX, 3/4-1HP, 3 PH	1
	111858.0006	ELEC BOX, 575V	11
2	111536.0001	SPROCKET, #25, 1/4P, 28T	1
3	111863.0001	ENCLOSURE ASSY, LIMIT, RHXH	1
4	111525.0001	ENCLOSURE, LIMIT, RHXH	1
5	111421.0001	LIMIT MODULE	1
6	086565.1032	CHAIN, RLR, #25 X 76P, LOOP	1
7	111537.0001	SPROCKET, #25, 1/4P, 38T	1
8		HOIST SHAFT KIT SHOWN ON PAGE 10.4	1
9	111527.0001	ENCLOSURE ASSY, BRAKE, RHXH	1
10	111503.0002	GEAR REDUCER, 20:1, RHXH	1
11		MOTOR, SEE PAGE 10.5	1
12		BRAKE/RELEASE ASSY, ON PAGE 10.6	1

Section 10: Appendix A

Operator Parts Breakdown Three HP

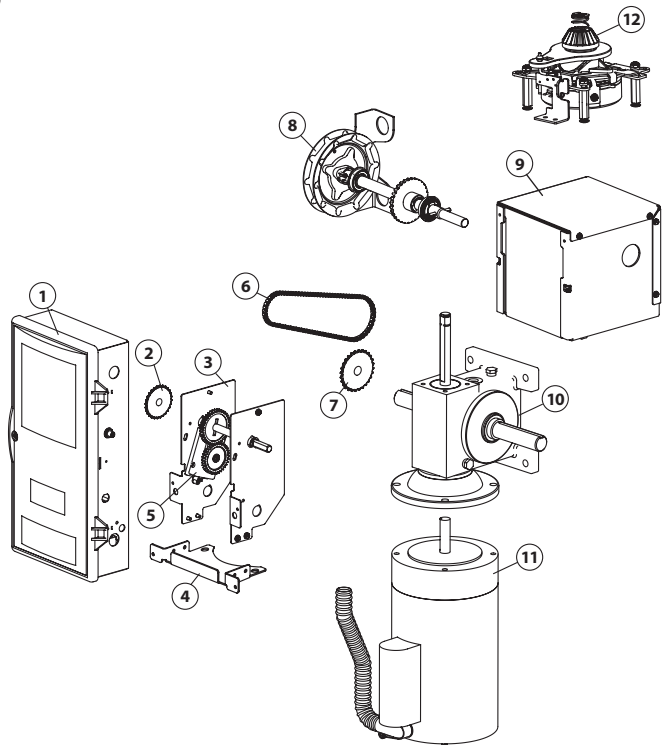

Item	Part Number	Description	Qty
	111587.0001	OPER ASSY, RHXH, 3HP	
1	111858.0001	ELEC BOX, 1/2HP, 1 PH	1
	111858.0002	ELEC BOX, 3/4HP, 1 PH	1
	111858.0003	ELEC BOX, 1HP, 1 PH	1
	111858.0004	ELEC BOX, 1/2HP, 3 PH	1
	111858.0005	ELEC BOX, 3/4-1HP, 3 PH	1
	111858.0006	ELEC BOX, 575V	11
2	111536.0001	SPROCKET, #25, 1/4P, 28T	1
3	111863.0002	ENCLOSURE ASSY, LIMIT, RHXH	1
4	111545.0001	ENCLOSURE, LIMIT, RHXH	1
5	111421.0001	LIMIT MODULE	1
6	086565.1031	CHAIN, RLR, #25 X 92P, LOOP	1
7	111537.0002	SPROCKET, #25, 1/4P, 38T	1
8		HOIST SHAFT KIT SHOWN ON PAGE 10.4	1
9	111546.0001	ENCLOSURE ASSY, BRAKE, RHXH	1
10	111544.0001	GEAR REDUCER, 20:1, RHXH	1
11		MOTOR, SEE PAGE 10.5	1
12		BRAKE/RELEASE ASSY, ON PAGE 10.6	1

Section 10: Appendix A

Wall Mount Kit (Indirect Couple)

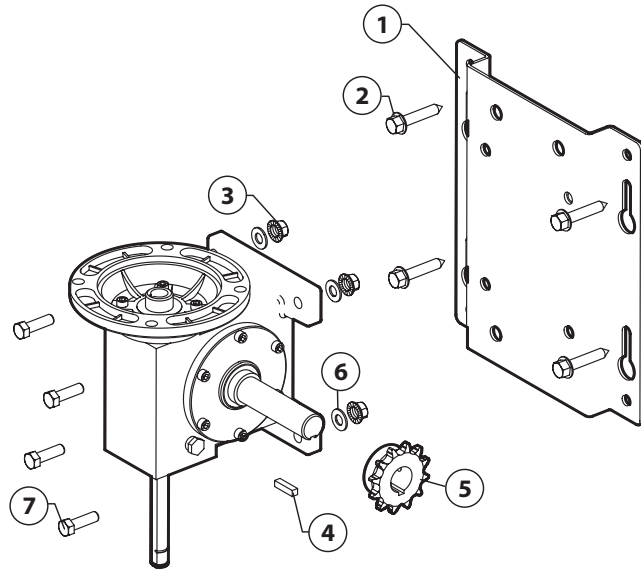

Item	Part Number	Description	Qty
1	111551.0001	BRKT, WALL MOUNT, RXHX	1
2	111632.0001	SCR, LAG, HWH, 3/8 X 2" LG	4
3	086480.2416	NUT, HEX, W/LK WSHR, 3/8-16	4
4	080340.0015	KEY, STD, SQ, 1/4 X 1" L	1
5	086446.1216	SPRKT ASSY, #50-12T, 1" BORE	1
6	080302.2626	WSHR, FLAT	4
7	080105.0610	BOLT, HH, PLD, 3/8-16 X 1-1/4" L	4

Appendix A (continued)

Hoist Shaft

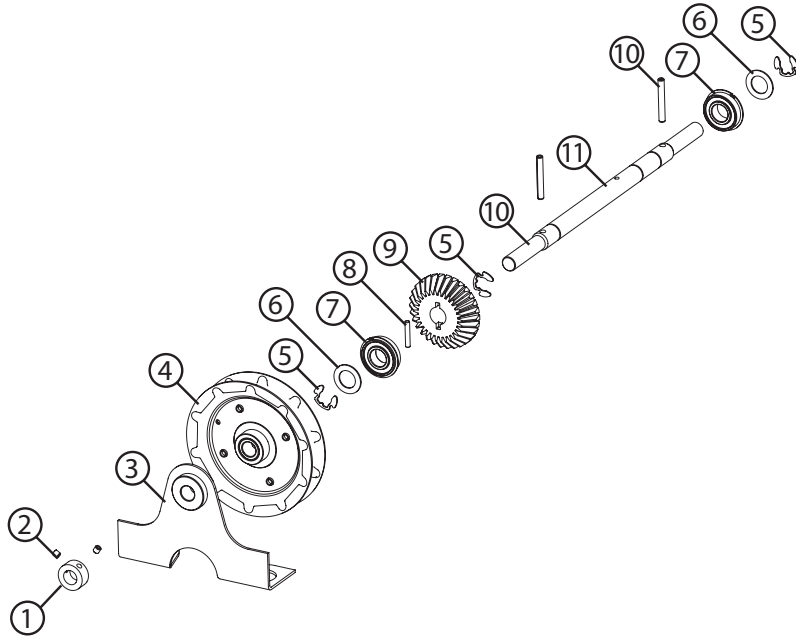

Item	Part Number	Description	Qty
A	111859.0001	SHAFT ASSY, HOIST, RHXH	
1	604297.3062	SET CLR, 5/8 ID X 1-1/8" OD	1
2	080300.1604	SCR, SET, SCH, KNRLD, 1/4-2	2
3	110411.0001	CHAIN GUARD ASSY	1
4	110872.0001	HANDWHEEL, STANDARD CHAIN	1
5	111382.0003	RING, RTNG, HIGH GRIP, .50	3
6	110819.0001	WASHER, PLAIN, .651 ID	2
7	110813.0001	BEARING, .625 ID	2
8	110881.0001	PIN, DOWEL, .188 X 1.13/1	1
9	111531.0002	GEAR, BEVEL, 36T, RHX	1
10	110313.0007	PIN, SPRING, .250 DIA X 1.88	2
11	111529.0001	SHAFT, HOIST, RHXH	1
B	111860.0001	SHAFT ASSY, HOIST, RHXH, 3HP	
1	604297.3062	SET CLR, 5/8 ID X 1-1/8" OD	1
2	080300.1604	SCR, SET, SCH, KNRLD, 1/4-2	2
3	110411.0001	CHAIN GUARD ASSY	1
4	110872.0001	HANDWHEEL, STANDARD CHAIN	1
5	111382.0003	RING, RTNG, HIGH GRIP, .50	3
6	110819.0001	WASHER, PLAIN, .770 ID	2
7	110695.0001	BEARING, .75 ID	2
8	110881.0001	PIN, DOWEL, .188 X 1.13/1	1
9	111552.0001	GEAR, BEVEL, 30T, HOIST	1
10	110313.0007	PIN, SPRING, .250 DIA X 1.88	2
11	111554.0001	SHAFT, HOIST, RHXH, 3HP	1

Appendix A (continued)

Motor Options

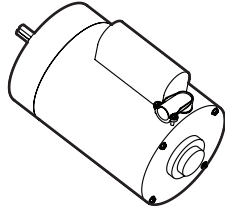

111502.0001—1/2HP, 1 PH, ODP
 111502.0002—3/4HP, 1 PH, ODP
 111502.0003—1HP, 1 PH, ODP
 111502.0004—1/2HP, 3 PH, ODP
 111502.0005—3/4HP, 3 PH, ODP
 111502.0006—1HP, 3 PH, ODP
 111502.0007—1/2HP, 575V, ODP
 111502.0008—3/4HP, 575V, ODP
 111502.0009—1HP, 575V, ODP

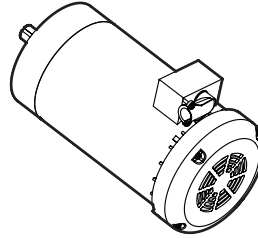

111548.0001—3HP, 3 PH, FC
 111548.0002—3HP, 575V, FC

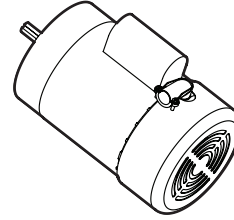

111694.0001—1/2HP, 1 PH, TEFC
 111694.0002—1HP, 1 PH, TEFC

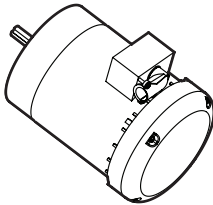

111695.0001—1/2HP, 3 PH, TEFC
 111695.0002—1HP, 3 PH, TEFC
 111695.0003—1HP, 575V, TEFC

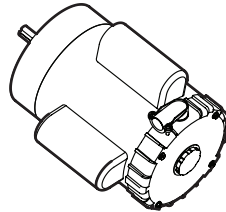

111696.0001—1/2HP, 1 PH, TENV
 111696.0002—1/2HP, 3 PH, TENV
 111696.0003—1HP, 3 PH, TENV
 111696.0004—1HP, 575V, TENV

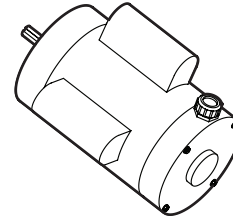

111697.0001—1/2HP, 1 PH, N4
 111697.0002—1HP, 1 PH, N4
 111697.0003—1/2HP, 3 PH, N4
 111697.0004—1HP, 3 PH, N4
 111697.0004—1HP, 575V, N4

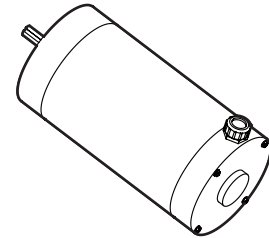

111698.0001—3HP, 3 PH, N4

Appendix A (cont')

Clutch (Optional)

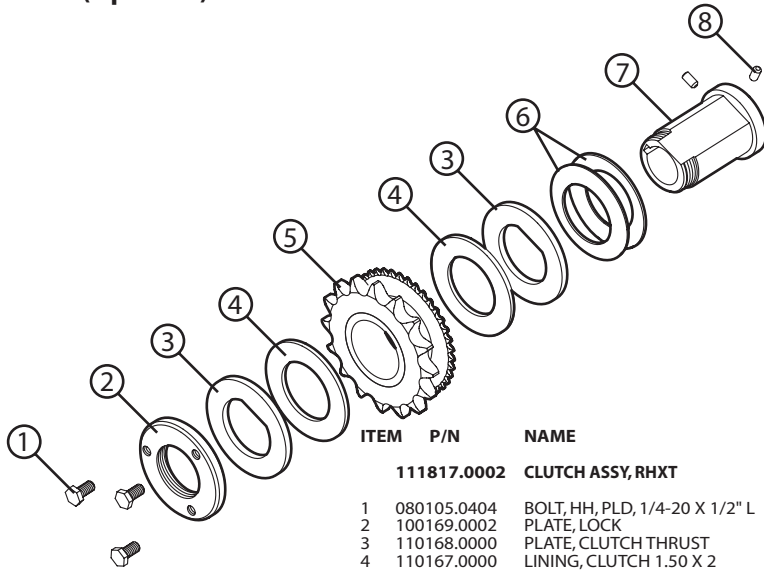

ITEM	P/N	NAME	QTY
111817.0002 CLUTCH ASSY, RHXT			
1	080105.0404	BOLT, HH, PLD, 1/4-20 X 1/2" L	3
2	100169.0002	PLATE, LOCK	1
3	110168.0000	PLATE, CLUTCH THRUST	2
4	110167.0000	LINING, CLUTCH 1.50 X 2	2
5	100171.0001	SPRKT ASSY, DUAL CLUTCH	1
6	600170.0000	WASHER, BELVILLE	2
7	100172.0004	SHAFT, CLUTCH	1
8	607037.1006	SCREW, SET, 10-32 X 3/8	2

Brake/Release Assemblies

Item	Part Number	Description	Qty
A	111861.0001	BRAKE ASSY, RHX	
B	111862.0001	BRAKE ASSY, RHX, 3HP	
Release Assembly			
1	111403.0001	WASHER, THRUST	2
2	111599.0001	RELEASE, HANDWHEEL, RHXH	1
3	111402.0001	BEARING, THRUST	1
4	111539.0001	GEAR, PINION, 18T, 1HP	1
	111553.0001	GEAR, BEVEL, 30T, 3HP	1
5	111555.0001	SPRING, .796 OD	1
6	111600.0001	RING, CONSTANT SECTION	1
7	111382.0002	RING, RTNG, HIGH GRIP, 406 DIA 1	1

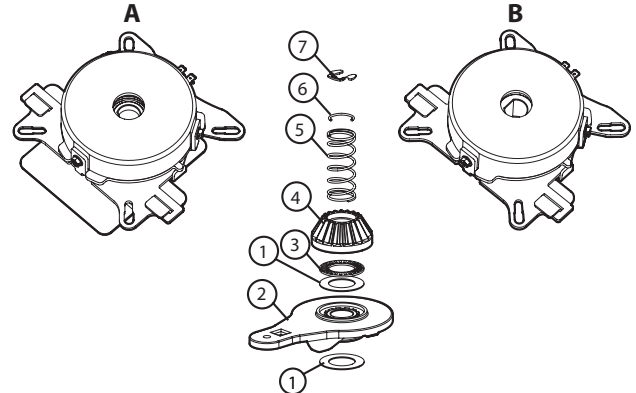

Appendix A (cont')

Base Electric Box Parts Breakdown

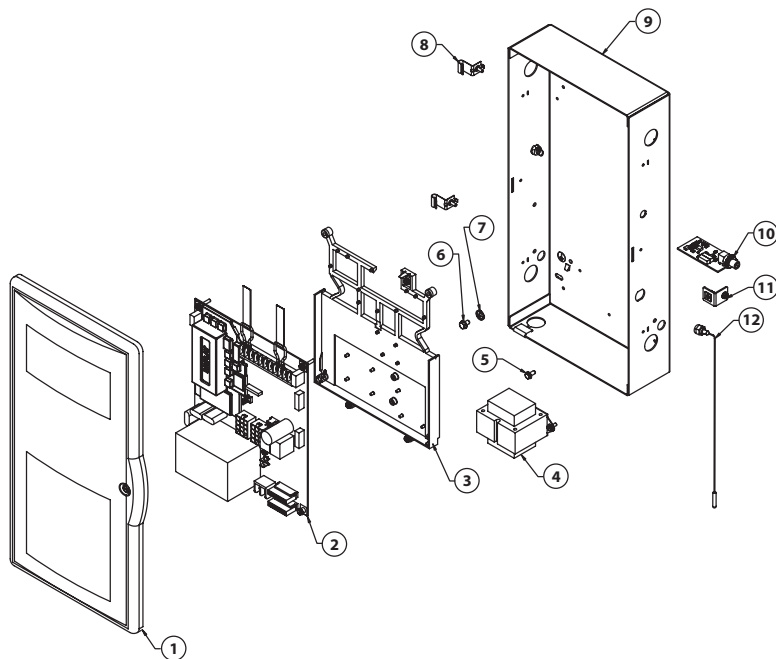

Item	Part Number	Description	Qty
1	111853.0001	COVER ASSY, 1 PHASE	1
	111853.0002	COVER ASSY, 3 PHASE	1
	111853.0003	COVER ASSY, 575V	1
2	111854.0001	CIRCUIT BOARD ASSY, 1 PHASE, 1/2 HP	1
	111854.0002	CIRCUIT BOARD ASSY, 1 PHASE, 3/4 - 1HP	1
	111854.0003	CIRCUIT BOARD ASSY, 3 PHASE, 1/2HP	1
	111854.0004	CIRCUIT BOARD ASSY, 3 PHASE, 3/4 - 1HP	1
	111854.0005	CIRCUIT BOARD ASSY, 575V	1
3	111401.0001	INSULATOR BOARD ASSY	1
4	111087.0001	XFMR, 115/208/230V, 1 PHASE	1
	111087.0002	XFMR, 208/230/460V, 3 PHASE	1
	111087.0003	XFMR, 575V	1
5	8706.E29	SCREW, GROUND, #8-32 X 3/8"	1
6	8706.F29	SCREW, GROUND, #10-32 X 3/8"	1
7	22634A	WASHER, CUP	1
8	110950.0001	HINGE ASSY	2
9	110630.0001	ELECTRIC BOX	1
10	111397.0001	RECEIVER ASSY	1
11	111398.0001	LATCH ASSY	1
12	111352.0001	ANTENNA ASSY	1
NS	111405.0001	SPARE FUSE KIT	1

NS=NOT SHOWN

Appendix A (cont')

Electric Box Layout

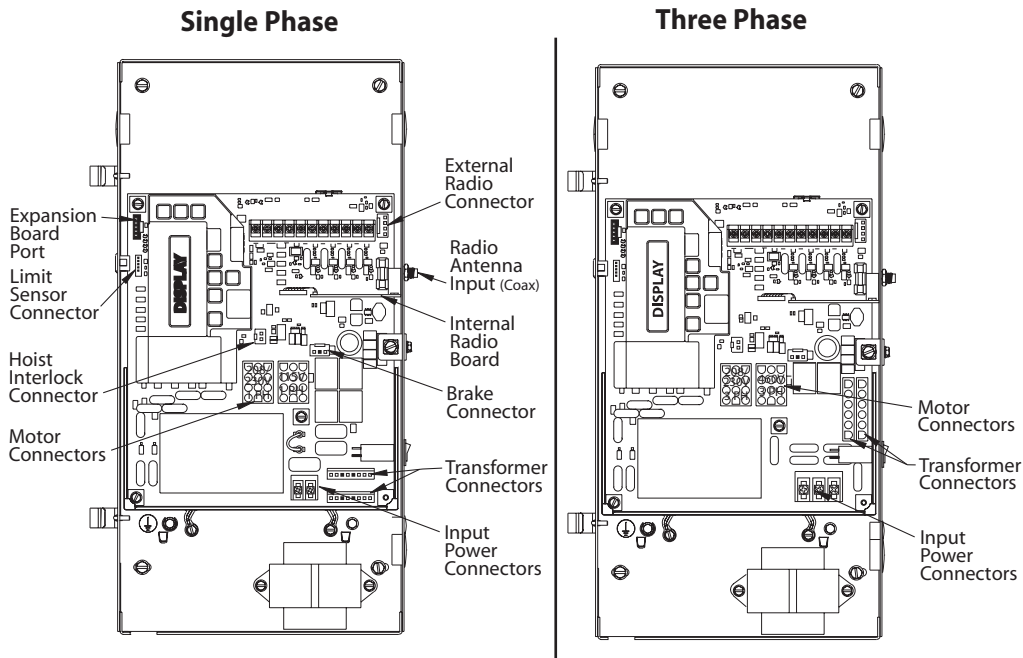

Appendix B

SECTIONAL SIDE/CENTER – Match RHX Hoist with Sect. Mounting Kit Below

MOUNTING KITS / BRACKETS SECTIONAL DOORS

TOP LEVEL KIT P/N	HP	DESCRIPTION
OPMKDC26HX.S	1/2,3/4,1	Mounting Kit, DC, 26 RPM, RHX
OPMKDC14HX.S	1/2,3/4,1	Mounting Kit, DC, 14 RPM, RHX
OPMKDC14HX3HP.S	3	Mounting Kit, DC, 14 RPM, RHX, 3HP
OPAKSMTHX.S	1/2,3/4,1	SIDE MOUNT TROLLEY, RHX
OPMKCMHHX.S	1/2,3/4,1	CENTERMOUNT (HORIZONTAL)
OPMKCMVHX.S	1/2,3/4,1	CENTERMOUNT (VERTICAL)
OPMKCMHHX3HPS	3	CENTERMOUNT (HORIZONTAL)
OPMKCMVHX3HPS	3	CENTERMOUNT (VERTICAL)
OPMKWMHX.S	1/2,3/4,1	Mounting Kit, Wall Mount, RHX
OPMKWMHX3HPS	3	Mounting Kit, Wall Mount, RHX

ROLLING STEEL - Match RHX Hoist with Rolling Steel Mounting Kit Below

MOUNTING KITS / BRACKETS ROLLING STEEL DOORS

TOP LEVEL KIT P/N	HP	DESCRIPTION
OPMKWMHX.S	1/2,3/4,1	Mounting Kit, Wall Mount, RHX
OPMKRSHX.S	1/2,3/4,1	Mounting Kit, RS, RHX, FOH/TOH
OPMKRSHX3HPS	3	Mounting Kit, RS, RHX, FOH/TOH
111767.0001	1/2,3/4,1	FOH/TOH, 3" SIDEROOM BRACKET
OPMKRSBMHX.S	1/2,3/4,1	BENCH MOUNT
111687.0001	1/2,3/4,1	FIRE DOOR BRACKET, RH
111687.0002	1/2,3/4,1	FIRE DOOR BRACKET, LH
OPMKRSBMHX3HPS	3	BENCH MOUNT
OPAKLEHX.S	1/2,3/4,1	LIMIT EXTENSION KIT

Step 1: Select the correct #50 door sprocket based on door shaft diameter.

Rolling Steel Sprocket by Door Shaft Dia.

Shaft Dia.	# Teeth	Sprocket P/N	KIT P/N
1	36	086446.3616	111381.0001.S
1.25	36	086446.3620	111381.0002.S
1.375	48	086446.4822	111381.0003.S
1.75	60	086446.6028	111381.0004.S

Section 10: Appendix C

Screw Terminal Assignments

INPUT	FUNCTION	CONNECTION TYPE	
11-POSITION TERMINAL BLOCK INSIDE ELECTRIC BOX	OPEN	Causes door to open if not at Up Limit. Causes a closing door to reverse.	Normally-Open Dry Contact to GND.
	CLOSE	Causes door to close if not at Down Limit.	Normally-Open Dry Contact to GND.
	STOP	Causes a moving door to stop. Prevents the operator from running.	Normally-Closed Dry Contact to GND.
	GND	Common ground connection for Open, Close, Stop & 1-Btn Inputs.	
	1-BTN	Causes door to open if not at Up Limit or Mid-Stop Limit. Causes door to close if at Up Limit or Mid-Stop Limit. Causes door to stop if opening. Causes a closing door to reverse.	Normally-Open Dry Contact to GND.
	ODC STB	Reverses a closing door if photocell beam is blocked. NOTE: STB's must be enabled in Calibration Mode.	ODC Series II Safe-T-Beams® ONLY to these inputs. (not polarity sensitive)
	ODC STB	Reverses a closing door if photocell beam is blocked. NOTE: STB's must be enabled in Calibration Mode.	ODC Series II Safe-T-Beams® ONLY to these inputs. (not polarity sensitive)
	N-O REVERSE	Causes a closing door to reverse. NOTE: Will not open a stopped door.	Normally-Open 2-Wire Non-Monitored Edge Sensor. (not polarity sensitive)
	N-O REVERSE	Causes a closing door to reverse. NOTE: Will not open a stopped door.	Normally-Open 2-Wire Non-Monitored Edge Sensor. (not polarity sensitive)
	EXT INTLK	Causes a moving door to stop. Prevents the operator from running when contact is open. Operates even if microcontroller is non-functional.	Normally-Closed dry contacts. (board will energize these contacts at nominal +24VDC).
	EXT INTLK	Causes a moving door to stop. Prevents the operator from running when contact is open. Operates even if microcontroller is non-functional.	Normally-Closed dry contacts. (board will energize these contacts at nominal +24VDC).
2-POSITION TERMINAL BLOCK (INSIDE ELECTRIC BOX)	L1 / L1	Power to RSX™ operator.	120VAC: Connect to Line (Hot) / 240VAC: Connect to Line 1.
	N / L2	Power to RSX™ operator.	120VAC: Connect to Neutral / 240VAC: Connect to Line 2.
RADIO AND ACCESSORIES PIGTAIL	PWR	Power for radio & other accessories. +20 to +40VDC, fused at 250mA (F1).	Connect to radio or other accessory's power input.
	RAD (Radio Input Control)	Causes door to open if not at Up Limit or Mid-Stop Limit. Causes door to close if at Up Limit or Mid-Stop Limit. Causes a closing door to reverse.	
	GND	Common ground connection for PWR and RAD terminals.	Connect to radio or other accessory's ground input.
PLUG CONNECTIONS INSIDE ELECTRIC BOX	EXPANSION PORT	Connects accessory modules to RSX™ operator.	Accessory Module Ribbon Cable.
	TRANSFORMER	Connects main transformer to control board.	Transformer Plug.
	BRAKE	Connects brake solenoid to control board.	Brake Solenoid Plug.
	MOTOR	Connects motor and capacitor to control board.	Motor Plug.
	HOIST INTLK	Causes moving door to stop. Prevents the operator from running. Operates even if microcontroller is non-functional.	Hoist Interlock Plug or Jumper.
	LIMIT SENSOR	Causes door to stop at top and bottom of normal travel.	Limit Sensor Plug.

Section 10: Appendix D

Run Code Displays

Condition Code	DISPLAY	Condition Code Description
0C	IDLE > DOWN LIMIT	STANDING BY AT DOWN LIMIT (NOTE: THIS MESSAGE IS DISPLAYED IF BOTH LIMITS ARE ACTIVE)
0D	IDLE > UP LIMIT	STANDING BY AT UP LIMIT
0E	IDLE > MID STOP	STANDING BY AT MID-STOP LIMIT
0F	IDLE > NO LIMIT	STANDING BY BETWEEN LIMITS
10	OPENING > OPEN BTN	OPENING FROM OPEN BUTTON
11	OPENING > ONE BTN	OPENING FROM 1 BUTTON
12	OPENING > RADIO	OPENING FROM RADIO
13	OPENING > AUX OPEN	OPENING FROM AUXILIARY OPEN INPUT
14	OPENING > OPEN KEY	OPENING FROM KEYPAD OPEN KEY
20	CLOSING > CLOSE PB	CLOSING FROM CLOSE BUTTON
21	CLOSING > ONE BTN	CLOSING FROM 1 BUTTON
22	CLOSING > RADIO	CLOSING FROM RADIO
24	CLOSING > CLOSE KP	CLOSING FROM KEYPAD CLOSE KEY
2A	CLOSING > TCM CLS	CLOSING FROM TIMER CLOSE MODULE
2B	CLOSING > FDM CLS	CLOSING FROM FORE DOOR MODULE
30	HALT > WALL BUTTON	GDO STOPPED BECAUSE STOP OR OPEN BUTTON WAS ACTIVATED, POSSIBLY STARTING A REVERSAL
31	HALT > ONE BUTTON	GDO STOPPED BECAUSE 1 BUTTON WAS ACTIVATED, POSSIBLY STARTING A REVERSAL
32	HALT > RADIO	GDO STOPPED BECAUSE RADIO INPUT WAS ACTIVATED, STARTING A REVERSAL
33	HALT > AUX. OPEN	GDO STOPPED BECAUSE AUXILIARY OPEN INPUT WAS ACTIVATED, STARTING A REVERSAL
34	HALT > KEYPAD KEY	GDO STOPPED BECAUSE KEYPAD STOP OR OPEN KEY WAS ACTIVATED, POSSIBLY STARTING A REVERSAL
35	HALT > N-O SAFETY	GDO STOPPED BECAUSE N-O REVERSING INPUT WAS ACTIVATED, STARTING A REVERSAL
36	HALT > ODC STB	GDO STOPPED BECAUSE ODC STB WAS BLOCKED, STARTING A REVERSAL
37	HALT > N-C SAFETY	GDO STOPPED BECAUSE N-C REVERSING INPUT WAS ACTIVATED, STARTING A REVERSAL
38	HALT > MON. EDGE	GDO STOPPED BECAUSE MONITORED EDGE SENSOR INPUT WAS ACTIVATED, STARTING A REVERSAL
39	HALT > DOOR FORCE	GDO STOPPED BECAUSE THE FORCE REQUIRED TO OPERATE THE DOOR WAS TOO HIGH, POSSIBLY STARTING A REVERSAL
3A	HALT > LOSS OF C/C	GDO STOPPED BECAUSE CONSTANT CONTACT ON CONTROL REMOVED BEFORE REACHING A LIMIT, POSSIBLY STARTING A REVERSAL
3B	HALT > SHUTDOWN	GDO STOPPED BECAUSE THE GDO DETECTED A FAULT SUCH AS AN OPEN INTERLOCK, OVERHEATED MOTOR, ETC.
3C	HALT > DOWN LIMIT	GDO STOPPED BECAUSE IT REACHED THE DOWN LIMIT
3D	HALT > UP LIMIT	GDO STOPPED BECAUSE IT REACHED THE UP LIMIT
3E	HALT > MID STOP	GDO STOPPED BECAUSE IT REACHED THE MID-STOP LIMIT
3F	HALT > MODULE FAIL	GDO STOPPED BECAUSE AN EXPANSION MODULE WAS NOT WORKING PROPERLY
40	REV > OPEN BUTTON	GDO REVERSED BECAUSE THE OPEN BUTTON WAS ACTIVATED
41	REV > ONE BUTTON	GDO REVERSED BECAUSE THE 1 BUTTON WAS ACTIVATED
42	REV > RADIO	GDO REVERSED BECAUSE THE RADIO INPUT WAS ACTIVATED
43	REV > AUX OPEN	GDO REVERSED BECAUSE THE AUXILIARY OPEN INPUT WAS ACTIVATED
44	REV > OPEN KEY	GDO REVERSED BECAUSE THE KEYPAD OPEN KEY WAS ACTIVATED
45	REV > N-O SAFETY	GDO REVERSED BECAUSE THE N-O REVERSING INPUT WAS ACTIVATED

Appendix D (cont')

Error Code Displays

Condition Code	DISPLAY	Condition Code Description
46	REV > ODC STB	GDO REVERSED BECAUSE THE ODC STB WAS BLOCKED
47	REV > N-C SAFETY	GDO REVERSED BECAUSE THE N-C REVERSING INPUT WAS ACTIVATED
48	REV > MON. EDGE	GDO REVERSED BECAUSE THE MONITORED EDGE SENSOR WAS ACTIVATED
49	REV > DOOR FORCE	GDO REVERSED BECAUSE THE FORCE REQUIRED TO CLOSE THE DOOR WAS TOO HIGH
4A	REV > LOSS OF C/C	GDO REVERSED BECAUSE CONSTANT CONTACT ON THE CONTROL WAS REMOVED BEFORE REACHING THE DOWN LIMIT
4B	REV > MAX RUN TMR	GDO REVERSED BECAUSE THE CLUTCH SLIPPED OR SOME OTHER FAULT OCCURRED THAT ALLOWED THE GDO TO RUN TOO LONG
4F	REV > EXP MOD FAIL	GDO REVERSED BECAUSE AN EXPANSION MODULE WAS NOT WORKING PROPERLY
50	STOP > HOT MOTOR	GDO STOPPED BECAUSE THE MOTOR WAS OVERHEATED
51	STOP > OPEN MRT	GDO STOPPED BECAUSE THE CLUTCH SLIPPED OR SOME OTHER FAULT OCCURRED THAT ALLOWED THE GDO TO RUN OPEN TOO LONG
52	STOP > CLOSE MRT	GDO STOPPED BECAUSE THE CLUTCH SLIPPED OR SOME OTHER FAULT OCCURRED THAT ALLOWED THE GDO TO RUN DOWN TOO LONG
57	STOP > OPEN INTLK	GDO STOPPED BECAUSE THE HOIST INTERLOCK OR EXTERNAL INTERLOCK IS OPEN
58	STOP > WRONG GDO	GDO STOPPED BECAUSE THE BOARD IS SET FOR JACKSHAFT MODE, BUT INSTALLED IN A TROLLEY OPERATOR
59	STOP > DOOR FORCE	GDO STOPPED BECAUSE THE FORCE REQUIRED TO OPEN THE DOOR WAS TOO HIGH
5A	STOP > WRONG LIMIT	GDO STOPPED BECAUSE THE UP LIMIT ACTIVATED WHEN CLOSING OR THE DOWN LIMIT ACTIVATED WHEN OPENING
5B	STOP > WRONG DIR	GDO STOPPED BECAUSE THE DOOR MOVED IN THE WRONG DIRECTION
5C	STALL > DOWN LIMIT	GDO STOPPED BECAUSE IT COULDN'T LEAVE THE DOWN LIMIT DUE TO A SLIPPING CLUTCH OR OTHER PROBLEM
5D	STALL > UP LIMIT	GDO STOPPED BECAUSE IT COULDN'T LEAVE THE UP LIMIT DUE TO A SLIPPING CLUTCH OR OTHER PROBLEM
5E	STALL > MID-STOP	GDO STOPPED BECAUSE IT COULDN'T LEAVE THE MID-STOP LIMIT DUE TO A SLIPPING CLUTCH OR OTHER PROBLEM
60	CHECK STOP BTN	GDO WON'T RUN BECAUSE THE STOP BUTTON IS ACTIVE
61	TCM DISABLED	TIMER CLOSE WON'T WORK BECAUSE NO SAFETIES ARE ENABLED
62	NO RADIO >> C/C	RADIO INPUT WON'T WORK WITH OPEN OR CLOSE FUNCTION IN CONSTANT CONTACT MODE
63	CHECK AUX OPEN	GDO WON'T CLOSE BECAUSE AUXILIARY OPEN INPUT IS ACTIVE
64	CHECK STOP KEY	GDO WON'T RUN BECAUSE THE KEYPAD STOP KEY IS ACTIVE
65	CHECK N-O SAFETY	GDO WON'T CLOSE BECAUSE THE N-O REVERSING IS ACTIVE
66	CHECK ODC STB	GDO WON'T CLOSE BECAUSE THE ODC STB IS BLOCKED
67	CHECK N-C SAFETY	GDO WON'T CLOSE BECAUSE THE N-C REVERSING INPUT IS ACTIVE
68	CHECK MON. EDGE	GDO WON'T CLOSE BECAUSE THE MONITORED EDGE SENSOR IS ACTIVE
69	OVERHEATED MOTOR	GDO WON'T RUN BECAUSE THE MOTOR IS OVERHEATED
6A	POWER WIRING ERROR	GDO WON'T RUN BECAUSE
6B	FIRE DOOR SHTDN	GDO WON'T RUN BECAUSE OF LOSS OF POWER
6C	NO RUN > DOWN LIM	GDO WON'T CLOSE BECAUSE ITS ALREADY AT THE DOWN LIMIT
6D	NO RUN > UP LIMIT	GDO WON'T OPEN BECAUSE ITS ALREADY AT THE UP LIMIT
6E	NO RUN > MID STOP	GDO WON'T RUN BECAUSE ITS AT OR ABOVE THE MID-STOP LIMIT & CAN'T RUN UP & A REVERSING INPUT IS PREVENTING IT FROM CLOSING
6F	EXP MODULE FAIL	GDO WON'T RUN BECAUSE AN EXPANSION MODULE FAILURE IS PREVENTING IT

Appendix D (cont')

Error Codes Displays (continued)

Condition Code	DISPLAY	Condition Code Description
70	BOARD FAILURE 70	CONTROL BOARD FAILURE 70, CONTACT FACTORY TECHNICAL SERVICE DEPT.
71	BOARD FAILURE 71	CONTROL BOARD FAILURE 71, CONTACT FACTORY TECHNICAL SERVICE DEPT.
74	BOARD FAILURE 74	CONTROL BOARD FAILURE 74, CONTACT FACTORY TECHNICAL SERVICE DEPT.
75	BOARD FAILURE 75	CONTROL BOARD FAILURE 75, CONTACT FACTORY TECHNICAL SERVICE DEPT.
76	BOARD FAILURE 76	CONTROL BOARD FAILURE 76, CONTACT FACTORY TECHNICAL SERVICE DEPT.
77	BOARD FAILURE 77	CONTROL BOARD FAILURE 77, CONTACT FACTORY TECHNICAL SERVICE DEPT.
80	BOARD FAILURE 80	CONTROL BOARD FAILURE 80, CONTACT FACTORY TECHNICAL SERVICE DEPT.
81	BOARD FAILURE 81	CONTROL BOARD FAILURE 81, CONTACT FACTORY TECHNICAL SERVICE DEPT.
82	BOARD FAILURE 82	CONTROL BOARD FAILURE 82, CONTACT FACTORY TECHNICAL SERVICE DEPT.
83	BOARD FAILURE 83	CONTROL BOARD FAILURE 83, CONTACT FACTORY TECHNICAL SERVICE DEPT.
84	BOARD FAILURE 84	CONTROL BOARD FAILURE 84, CONTACT FACTORY TECHNICAL SERVICE DEPT.
85	EXP PORT PROBLEM	EXPANSION PORT IS SHORT CIRCUITED, TRY DISCONNECTING EXPANSION MODULES OR CONTACT FACTORY TECHNICAL SERVICE DEPT.
86	BOARD FAILURE 86	CONTROL BOARD FAILURE 86, DISCONNECT EXPANSION MODULES. IF NO CHANGE, CONTACT FACTORY TECHNICAL SERVICE DEPT.
87	IEM FAILURE	RESERVED--NOT CURRENTLY USED
88	TCM FAILURE	TIMER CLOSE MODULE (TCM) HAS FAILED
89	FDM FAILURE	FIRE DOOR MODULE (FDM) HAS FAILED
8A	AOM FAILURE	AUXILIARY OUTPUT MODULE (AOM) HAS FAILED
8B	SPARE MOD FAILURE	RESERVED--NOT CURRENTLY USED
8C	LOW SYSTEM VOLTS	POWER SUPPLY LINE VOLTAGE LOW
8D	HI SYSTEM VOLTS	POWER SUPPLY LINE VOLTAGE HIGH
8E	REV INTERRUPTED	GDO LOST POWER OR ENCOUNTERED ANOTHER PROBLEM DURING THE REVERSAL PROCESS, REVERSAL IS COMPLETING NOW
8F	LIMIT MOD. FAIL	GDO WON'T RUN, LIMIT MODULE HAS FAILED
90	DIAGNOSTIC MODE	GDO IS IN DIAGNOSTIC MODE, NORMAL FUNCTIONS ARE NOT ALLOWED
A0	OPEN BTN BAD > PU	OPEN & CLOSE BUTTONS WON'T WORK, THE OPEN BUTTON WAS ACTIVE WHEN THE GDO WAS POWERED-UP
A1	CLOSE BTN BAD > PU	OPEN & CLOSE BUTTONS WON'T WORK, THE CLOSE BUTTON WAS ACTIVE WHEN THE GDO WAS POWERED-UP
A2	ONE BTN BAD > PU	1 BUTTON WON'T WORK, THE 1 BUTTON WAS ACTIVE WHEN THE GDO WAS POWERED-UP
A3	RADIO BAD > PWR UP	RADIO INPUT WON'T WORK, THE RADIO INPUT WAS ACTIVE WHEN THE GDO WAS POWERED-UP
A4	AUX OPEN BAD > PU	AUXILIARY OPEN INPUT WON'T WORK, THE AUXILIARY OPEN INPUT WAS ACTIVE WHEN THE GDO WAS POWERED-UP
A5	OPEN KEY BAD > PU	KEYPAD OPEN & CLOSE KEYS WON'T WORK, THE OPEN KEY WAS ACTIVE WHEN THE GDO WAS POWERED-UP
A6	CLOSE KEY BAD > PU	KEYPAD OPEN & CLOSE KEYS WON'T WORK, THE CLOSE KEY WAS ACTIVE WHEN THE GDO WAS POWERED-UP
A7	MULT KEYS BAD > PU	1 OR MORE KEYPAD CALIBRATION KEYS WON'T WORK, 1 OR MORE WERE ACTIVE WHEN THE GDO WAS POWERED-UP
AA	TCM BAD > POWER UP	RESERVED--NOT CURRENTLY USED
AB	FDM BAD > POWER UP	RESERVED--NOT CURRENTLY USED
B0	OPENING > XMTR #	OPENING FROM TRANSMITTER # ___
B1	CLOSING > XMTR #	CLOSING FROM TRANSMITTER # ___
B2	HALT > XMTR #	HALT FROM TRANSMITTER # ___
B3	NO XMTR > CC	NO CONTROL FROM TRANSMITTER, CONSTANT CONTACT EMPLOYED AT LOCAL CONTROL

The Genuine. The Original.



FOR ASSISTANCE, CALL 800-275-6187

RHX[®]

HEAVY DUTY COMMERCIAL OPERATOR

The Genuine. The Original.



TORQUE LIMITER INSTALLATION SUPPLEMENT FOR ALL HP RATINGS RHX COMMERCIAL-INDUSTRIAL DOOR OPERATOR.

NOT FOR RESIDENTIAL USE

This supplement instruction is to be used in combination with the standard accompanying RHX[®] Installation Manual. This supplement contains adjustment and installation instruction and illustrated parts breakdowns which specify parts included in the Torque Limiter Kit.

IMPORTANT: Prior to installing or operating an RHX[®] Commercial-Industrial Door Operator, carefully read the RHX[®] Installation Manual and any other instructions and warnings accompanying the unit.

Adjustment Torque Limiter

The RHX[®] Clutch does not require any disassembly to adjust.

- 1) All adjustments should be made in very small amounts (e.g. turning adjustment bolts 1/2 of a flat at a time).
- 2) When making adjustments, be sure to turn all 3 adjustment bolts an equal amount. **Fig 12.**
 - To increase tension, turn adjustment bolts clockwise.
 - To decrease tension, turn adjustment bolts counter-clockwise.

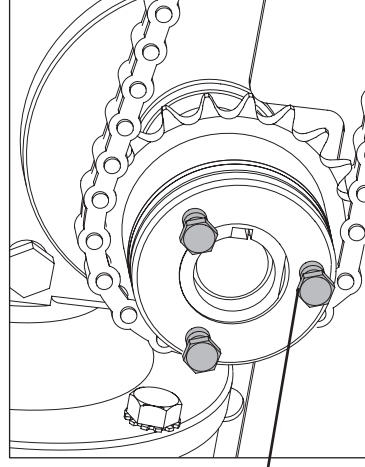

ADJUSTMENT BOLTS

Replacing Torque Limiter

While the Trolley Unit is shown, this is typical of all torque limiter applications and all follow the same basic procedure.

- 1) Turn off power to the operator. (It is highly recommended that a approved Tag Out/Lock Out procedure be used during any maintenance of the operator.)
- 2) Loosen set screws on the torque limiter and the limit shaft gear.
- 3) Remove the torque limiter, limit shaft gear and chain as a unit.
- 4) Make sure key is seated in the keyway.
- 5) With the chain looped around the new torque limiter and the limit shaft gear, slide all as a unit back onto their respective shafts. Once started onto their shafts, make sure the torque limiter is aligned with the key and slide fully into position.
- 6) Make sure the torque limiter and limit shaft gear are lined up so the chain is perpendicular to the shafts.
- 7) Tighten set screws.

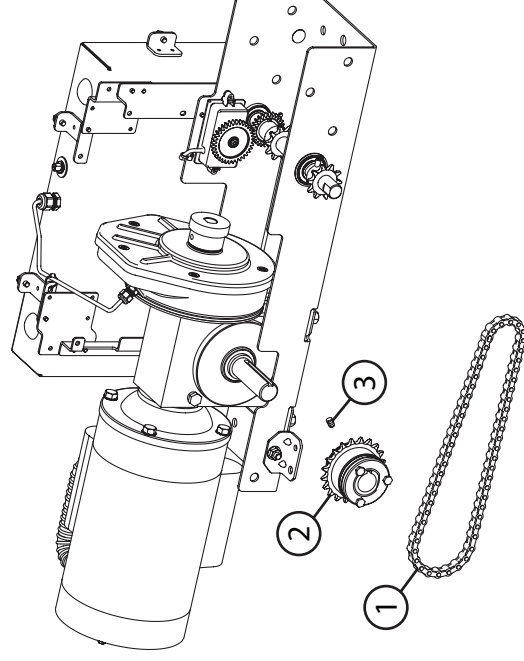

FOR ASSISTANCE, CALL 800-275-6187

RHX[®]
HEAVY DUTY COMMERCIAL OPERATOR

www.overheaddoor.com

11-10



WARRANTY

The Genuine. The Original.



RHX[®]

Commercial Operator Limited Warranty

The authorized distributor of Overhead Door Corporation products, whose name appears below ("Seller") warrants to the original purchaser of the model RHX[®] Trolley or RHX[®] Hoist commercial door operator ("Product"), subject to all of the terms and conditions hereof, that the Product and all components thereof will be free from defects in materials and workmanship under normal use for the following components thereof will be free from defects in materials and workmanship under normal use for the following period(s), measured from the date of installation:

- Two (2) years

Seller's obligation under this warranty is specifically limited to repairing or replacing, at its option, any part which is determined by Seller to be defective during the applicable warranty period. Any labor charges are excluded and will be the responsibility of the purchaser.

This warranty is made to the original purchaser of the Product only, and is not transferable or assignable. This warranty applies only to an operator which is installed in commercial or industrial building applications. This warranty does not apply to any unauthorized alteration or repair of the Product, or to any Product or component which has been damaged or deteriorated due to misuse, neglect, accident, failure to provide necessary maintenance, normal wear and tear, or acts of God or any other cause beyond the reasonable control of Seller.

THIS WARRANTY IS EXCLUSIVE AND IN LIEU OF ANY OTHER WARRANTIES, EITHER EXPRESS OR IMPLIED, INCLUDING BUT NOT LIMITED TO ANY IMPLIED WARRANTY OF MERCHANTABILITY OR FITNESS FOR A PARTICULAR PURPOSE.

IN NO EVENT SHALL SELLER BE RESPONSIBLE FOR, OR LIABLE TO ANYONE FOR, SPECIAL, INDIRECT, COLLATERAL, PUNITIVE, INCIDENTAL OR CONSEQUENTIAL DAMAGES, even if Seller has been advised of the possibility of such damages. Such excluded damages include, but are not limited to, loss of goodwill, loss of profits, loss of use, cost of any substitute product, interruption of business, or other similar indirect financial loss.

Claims under this warranty must be made promptly after discovery, within the applicable warranty period, and in writing to the Seller or to the authorized distributor or installer whose name and address appear below. The purchaser must allow Seller a reasonable opportunity to inspect any Product claimed to be defective prior to removal or any alteration of its condition. Proof of the purchase and/or installation date, and identification as the original purchaser, may be required.

ORIGINAL PURCHASER _____

INSTALLATION ADDRESS _____

SELLER: _____

SELLER'S ADDRESS: _____

FACTORY ORDER #: _____

DATE OF INSTALLATION: _____

SIGNATURE OF SELLER: _____



Overhead Door Corporation
2501 S. State Hwy 121 Bus., Suite 200
Lewisville, TX 75067
1-800-929-3667(DOOR)
www.overheaddoor.com
